



TIMBER NOTICE OF SALE

SALE NAME: RIDGE ENDER

AGREEMENT NO: 30-104444

AUCTION: June 12, 2024 starting at 10:00 a.m., COUNTY: Snohomish Northwest Region Office, Sedro Woolley, WA

SALE LOCATION: Sale located approximately 10 miles northeast of Sultan, WA.

PRODUCTS SOLD AND SALE AREA:

All timber bounded by white timber sale boundary tags, adjacent young stands (pink flagline), and the PT-14 and PT-ML roads, except cedar salvage (cedar snags, preexisting dead and down cedar trees and cedar logs), trees marked with blue paint on the bole and root collar, and forest products tagged out by yellow leave tree area tags in Unit #1.

All timber bounded by white timber sale boundary tags, adjacent young stands (pink flagline), and the HK-ML roads, except cedar salvage (cedar snags, preexisting dead and down cedar trees and cedar logs), trees marked with blue paint on the bole and root collar, and forest products tagged out by yellow leave tree area tags in Units #2 and #3.

All timber bounded by white timber sale boundary tags, adjacent young stands (pink flagline), and the HK-18 and HK-ML roads, except cedar salvage (cedar snags, preexisting dead and down cedar trees and cedar logs), trees marked with blue paint on the bole and root collar, and forest products tagged out by yellow leave tree area tags in Unit #4.

All timber bounded by white timber sale boundary tags, except cedar salvage (cedar snags, preexisting dead and down cedar trees and cedar logs), trees marked with blue paint on the bole and root collar, and forest products tagged out by yellow leave tree area tags in Unit #5 (collectively labeled 5A, 5B and 5C).

All timber bounded by orange right-of-way tags.

All forest products above located on part(s) of Sections 6 all in Township 28 North, Range 9 East, Sections 1, 2, 11 and 12 all in Township 28 North, Range 8 East, W.M., containing 146 acres, more or less.

CERTIFICATION: This sale is certified under the Sustainable Forestry Initiative® program Standard (cert no: BVC-SFIFM-018227)

ESTIMATED SALE VOLUMES AND QUALITY:

Table with columns: Species, Avg DBH, Ring Count, Total MBF, and MBF by Grade (1P, 2P, 3P, SM, 1S, 2S, 3S, 4S, UT). Rows include Douglas fir, Hemlock, Redcedar, Maple, Cottonwood, and Sale Total.

MINIMUM BID: \$0.00

BID METHOD: Sealed Bids



TIMBER NOTICE OF SALE

- SPECIAL REMARKS:**
1. HQ Douglas-fir as well as Douglas-fir and redcedar poles noted within the sale area. See cruise for further details.
 2. "No Entry Area"(s) are located adjacent to Unit 1, Unit 4, Unit 5A, and ROW1 where no activity is allowed to occur.
 3. Intermediate supports may be necessary.
 4. Cedar salvage may be offered for sale separately from the timber sale and is NOT included in the products sold.

DRAFT

TIMBER SALE MAP

SALE NAME: RIDGE ENDER
AGREEMENT #: 30-104444
TOWNSHIP(S): T28R8E, T28R9E
TRUST(S): Capitol Grant (7), Charitable/Educational/Penal & Reformatory Instit. (6), Common School and Indemnity (3)

REGION: Northwest Region
COUNTY(S): Snohomish
ELEVATION RGE: 1040-2080

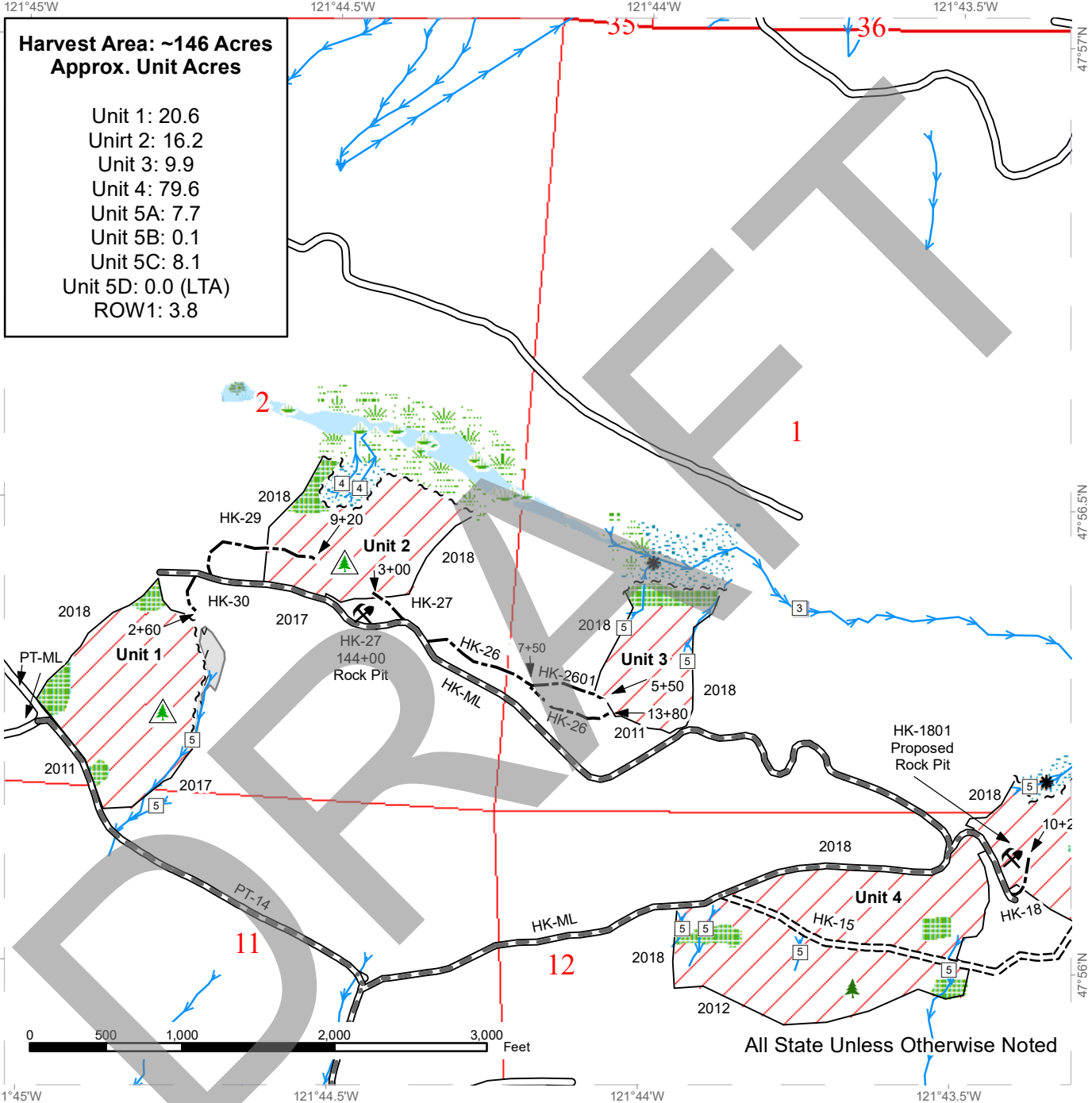

**Harvest Area: ~146 Acres
Approx. Unit Acres**

Unit 1:	20.6
Unit 2:	16.2
Unit 3:	9.9
Unit 4:	79.6
Unit 5A:	7.7
Unit 5B:	0.1
Unit 5C:	8.1
Unit 5D:	0.0 (LTA)
ROW1:	3.8

Variable Retention Harvest	Non-Tradeable Leave Trees	Wetland Mgt Zone
Existing Roads	Rock Pit	Stream Type 3
Required Pre-Haul Maintenance	No Entry Zone	Stream Type 4
Required Construction	Wetlands - Non-forested	Stream Type 5
Optional Construction	Leave Tree Area	Stream Break
Streams	Riparian Mgt Zone	
Leave Tree Area <1/4-acre	Forested Wetland	



TIMBER SALE MAP

SALE NAME: RIDGE ENDER
AGREEMENT #: 30-104444
TOWNSHIP(S): T28R8E, T28R9E
TRUST(S): Capitol Grant (7), Charitable/Educational/Penal & Reformatory Instit. (6), Common School and Indemnity (3)

REGION: Northwest Region
COUNTY(S): Snohomish
ELEVATION RGE: 1040-2080

Harvest Area: ~146 Acres
Approx. Unit Acres

- Unit 1: 20.6
- Unit 2: 16.2
- Unit 3: 9.9
- Unit 4: 79.6
- Unit 5A: 7.7
- Unit 5B: 0.1
- Unit 5C: 8.1
- Unit 5D: 0.0 (LTA)
- ROW1: 3.8

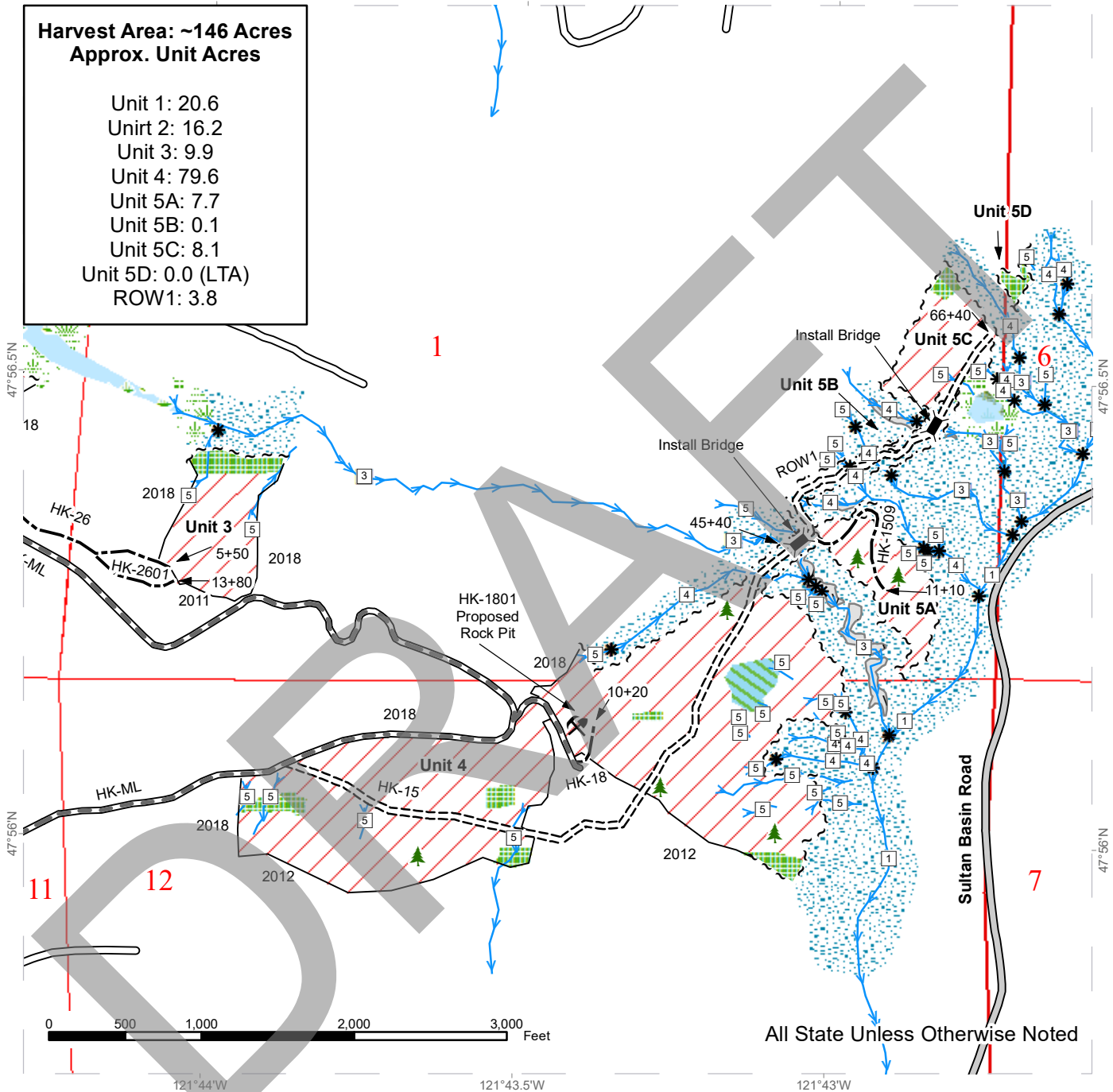

All State Unless Otherwise Noted

Variable Retention Harvest	Leave Tree Area <1/4-acre	Wetland Mgt Zone
County Road	Rock Pit	Stream Type 1
Existing Roads	No Entry Zone	Stream Type 3
Required Pre-Haul Maintenance	Wetlands - Non-forested	Stream Type 4
Required Construction	Non-Tradeable Leave Clump	Stream Type 5
Optional Construction	Leave Tree Area	Stream Break
Streams	Riparian Mgt Zone	
Bridge	Forested Wetland	



DRIVING MAP

SALE NAME: RIDGE ENDER
AGREEMENT#: 30-104444
TOWNSHIP(S): T28R8E, T28R9E
TRUST(S): Capitol Grant (7), Charitable/Educational/Penal & Reformatory Instit. (6), Common School and Indemnity (3)

REGION: Northwest Region
COUNTY(S): Snohomish
ELEVATION RGE: 1040-2080

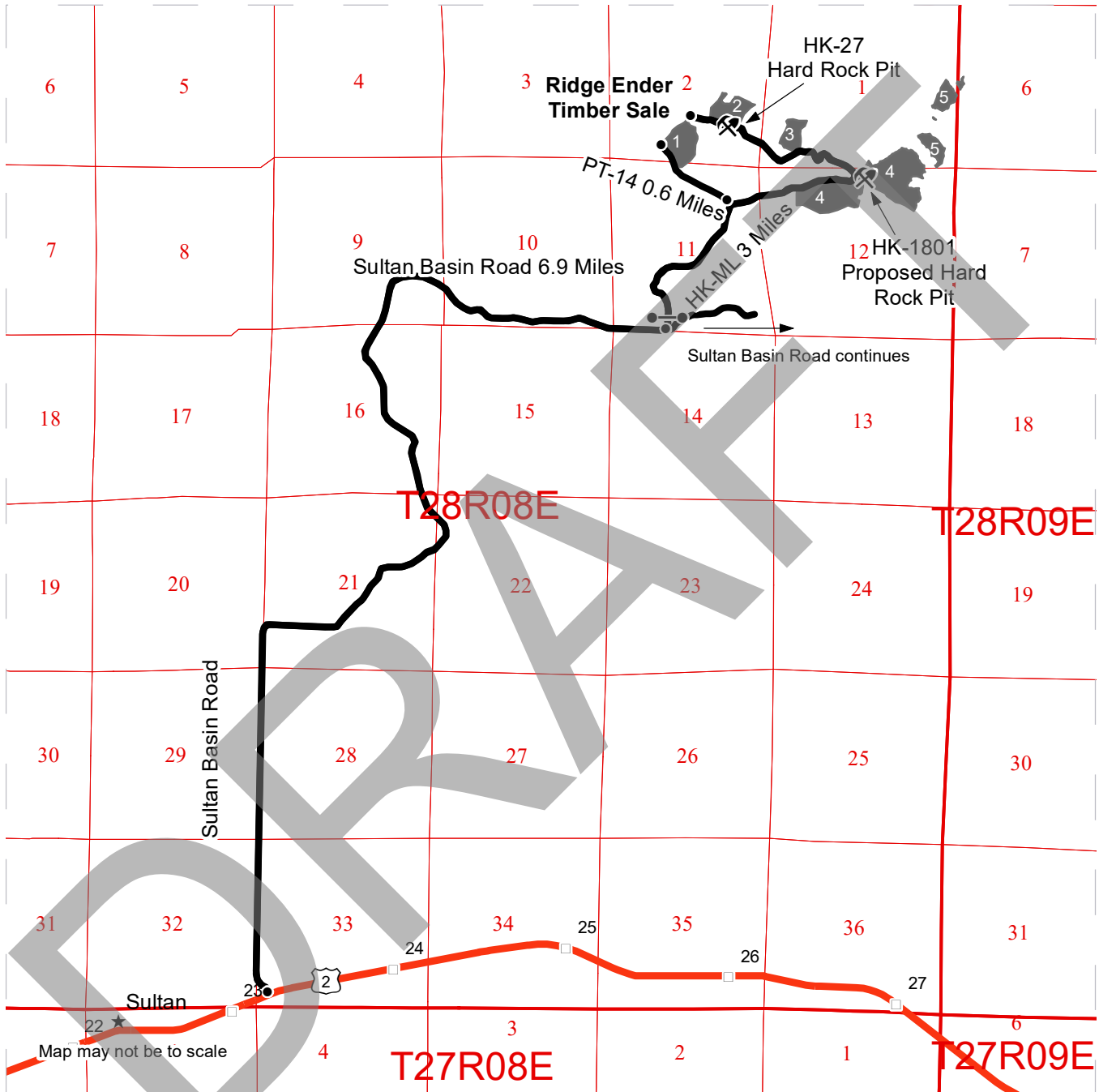

- Milepost Markers
- Haul Route
- Timber Sale Unit
- US Route 2
- Public Land Survey Townships
- Public Land Survey Sections
- Distance Indicator
- Gate (F1-3)
- ⛏ Rock Pit

DRIVING DIRECTIONS:

All Units
 Follow US Route 2 one mile east of Sultan to reach the intersection with Sultan Basin Road. Turn left at the traffic light onto Sultan Basin Road and continue for 6.9 miles. Turn left on to the HK-ML mainline; F1-3 key required. The HK-ML continues for 3 miles; all units are accessible from this road.

Unit 1
 Unit 1 can also be accessed from the bottom by following the PT-14 off of the HK-ML. At the second fork on the HK-ML, turn left. Continue for approximately 2100 feet; Unit 1 will be on the right flank of the road.



Project Name: Ridge Ender
Lead Cruiser: Matt Llobet

For this cruise different basal area factors were selected based on stoking levels, tree sizes, topography, and understory conditions. The smallest merchantable tree cruised throughout the sale had a DBH of 7.0 inches and 5.0 inches at 16 feet. My plots were generated in GIS and located in the field using Avenza Maps. Bole height was measured with a laser and taken to a 5" top or break point (40% of diameter at 16 feet). Trees were segmented into preferred west-side log lengths while taking into account location of defect within each tree cruised.

- Conifer log lengths were cruised in 2 foot multiples - maximizing 32-40 ft. lengths.
- Hardwood log lengths were cruised in 10 foot multiples - no longer than 30 feet long.

My total net cruise volume for the Ridge Ender TS is 6,602 MBF. Observed throughout all five units was a variable stocking with Douglas fir and Western Hemlock being the dominant species.

Species Composition

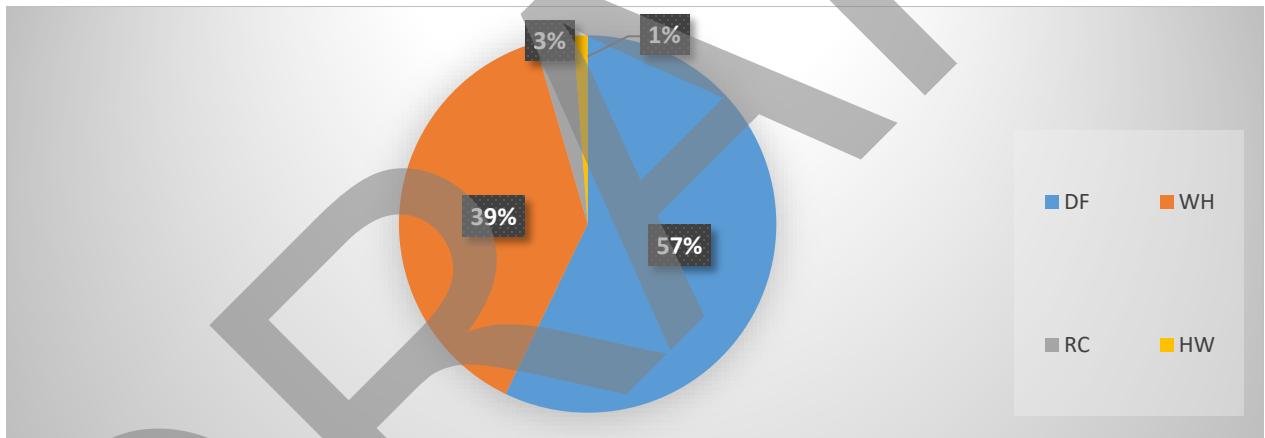

Unit 1:

The stand characteristics throughout unit 1 showed a variable species composition with minor vegetation throughout the understory. The terrain throughout unit 1 was steep in the central and northern portions, with mild topography in the south portion. Unit 1 cruised out at 28,155 bf per acre and all live timber showed good form. The species composition consists of Douglas fir, Western Hemlock, Western Red Cedar, and scattered hardwoods. The Douglas fir made up 82% of the unit volume amounting to 477 mbf.

Unit 2 & 3:

These stands consist of a variable timber type with mild brush throughout the understory. Western Hemlock was the dominant species - making up 70% of the volume. The operator

ground was steep with scattered rocky outcroppings in the central portion of both units. The species composition consists of Douglas fir, Western Hemlock, and scattered Western Red Cedar.

Unit 4:

The stand characteristics showed a variable stocking with Douglas fir and Western Hemlock being the dominant species. Unit 4 cruised out at 52,918 bf per acre and all live timber showed good form. Douglas fir makes up 63% of the unit volume, amounting to 2,645 mbf, while WH makes up 32%. High Quality Douglas fir logs were sampled, amounting to 690 mbf. Also sampled throughout unit 4 was pole quality logs in both the Douglas fir and Western Red Cedar. Most of the unit 4 consists of mild terrain, making for productive operator ground.

Unit 5:

Unit 5 showed a variable stocking with Douglas fir and Western Hemlock being the dominant species. Most of unit 5 consists of mild terrain, making for productive operator ground.

ROW:

The ROW volume associated with Ridge Ender was a combination of old road grade and new construction. The ROW units cruised out at 39,082 bf per acre and all timber showed excellent form.

Timber Sale Cruise Report Ridge Ender - NW

Sale Name: RIDGE ENDER

Sale Type: LUMP SUM

Region: NORTHWEST

District: CASCADE

Lead Cruiser: Matt Llobet

Timber Sale Notice Volume (MBF)

Sp	DBH	Rings/In	Age	MBF Volume by Grade					
				All	Spec Mill	2 Saw	3 Saw	4 Saw	Utility
DF	24.2	11.7		3,774	271	2,867	595	41	
WH	18.5			2,531		1,500	900	75	55
RC	21.0			218			206	12	
MA	15.9			71		32	24	7	8
BC	29.3			8		8			
ALL	21.1	11.8		6,602	271	4,407	1,725	135	64

Timber Sale Notice Weight (tons)

Sp	Tons by Grade					
	All	Spec Mill	2 Saw	3 Saw	4 Saw	Utility
DF	24,128	1,611	17,412	4,720	385	
WH	20,514		11,196	8,118	752	449
RC	1,766			1,673	93	
MA	459		194	149	57	59
BC	53		53			
ALL	46,921	1,611	28,855	14,661	1,286	508

Timber Sale Overall Cruise Statistics

BA (sq ft/acre)	BA SE (%)	V-BAR (bf/sq ft)	V-BAR SE (%)	Net Vol (bf/acre)	Vol SE (%)
251.8	4.0	177.5	1.8	45,127	4.5

Timber Sale Unit Cruise Design

Unit	Design	Cruise Acres	FMA Acres	N Plots	N Cruise Plots	N Void Plots
RIDGE ENDER U1	B2: VR, 2 BAF (54.44, 40 for some species) Measure All, Sighting Ht = 4.5 ft	20.6	22.8	18	18	0
RIDGE ENDER U2	B2: VR, 2 BAF (54.44, 40 for some species) Measure All, Sighting Ht = 4.5 ft	16.2	17.4	14	14	0
RIDGE ENDER U3	B2: VR, 2 BAF (62.5, 40 for some species) Measure All, Sighting Ht = 4.5 ft	9.9	11.7	8	8	0
RIDGE ENDER U4	B2C: VR, 2 BAF (54.44, 40 for some species) Measure/Count Plots, Sighting Ht = 4.5 ft	79.6	85.9	46	24	1
RIDGE ENDER U5A	B2: VR, 2 BAF (54.44, 40 for some species) Measure All, Sighting Ht = 4.5 ft	7.7	8.3	4	4	0
RIDGE ENDER U5B	B1: VR, 1 BAF (54.44) Measure All, Sighting Ht = 4.5 ft	0.1	0.1	2	2	0
RIDGE ENDER U5C	B2: VR, 2 BAF (54.44, 40 for some species) Measure All, Sighting Ht = 4.5 ft	8.1	8.7	4	4	0
RIDGE ENDER ROW 1	B2C: VR, 2 BAF (54.44, 40 for some species) Measure/Count Plots, Sighting Ht = 4.5 ft	4.1	4.1	7	7	0
All		146.3	159.0	103	81	1

Timber Sale Log Grade x Sort Summary

Sp	Status	Grade	Sort	Dia	Len	BF Gross	BF Net	Defect %	Tons	MBF Net
BC	LIVE	2 SAW	Domestic	15.7	30	57	57	0.0	53.5	8.4
DF	LIVE	2 SAW	Domestic	16.5	38	15,392	15,077	2.0	13,290.7	2,205.7
DF	LIVE	2 SAW	HQ-A	14.7	38	1,244	1,244	0.0	1,211.8	181.9
DF	LIVE	2 SAW	HQ-B	18.2	40	2,774	2,758	0.6	2,351.0	403.5
DF	LIVE	2 SAW	Pole	13.8	40	525	519	1.2	558.1	75.9
DF	LIVE	3 SAW	Domestic	9.5	34	3,820	3,772	1.3	4,390.0	551.9
DF	LIVE	3 SAW	Pole	9.7	34	293	293	0.0	330.3	42.8
DF	LIVE	4 SAW	Domestic	7.2	22	264	248	6.1	348.7	36.3
DF	LIVE	4 SAW	Pole	8.2	24	30	30	0.0	36.7	4.4
DF	LIVE	CULL	Cull	19.4	7	31	0	100.0	0.0	0.0
DF	LIVE	SPECIAL MILL	HQ-A	19.6	38	1,885	1,855	1.6	1,611.1	271.4
MA	LIVE	2 SAW	Domestic	13.6	23	224	215	3.7	194.0	31.5

Sp	Status	Grade	Sort	Dia	Len	BF Gross	BF Net	Defect %	Tons	MBF Net
MA	LIVE	3 SAW	Domestic	10.3	23	164	164	0.0	149.2	23.9
MA	LIVE	4 SAW	Domestic	9.2	20	46	46	0.0	56.8	6.7
MA	LIVE	UTILITY	Pulp	8.7	22	58	58	0.0	58.9	8.4
RC	LIVE	3 SAW	Domestic	10.6	34	865	842	2.6	1,070.6	123.2
RC	LIVE	3 SAW	Pole	11.0	37	564	564	0.0	602.4	82.6
RC	LIVE	4 SAW	Domestic	6.0	21	67	67	0.0	73.6	9.8
RC	LIVE	4 SAW	Pole	8.1	18	17	17	0.0	19.0	2.5
RC	LIVE	CULL	Cull	13.8	8	28	0	100.0	0.0	0.0
WH	LIVE	2 SAW	Domestic	14.6	38	10,371	10,255	1.1	11,195.6	1,500.4
WH	LIVE	3 SAW	Domestic	8.9	36	6,202	6,154	0.8	8,118.3	900.3
WH	LIVE	4 SAW	Domestic	6.3	25	514	513	0.3	751.6	75.0
WH	LIVE	CULL	Cull	23.3	6	115	0	100.0	0.0	0.0
WH	LIVE	UTILITY	Pulp	8.0	34	378	378	0.0	448.9	55.3

Timber Sale Log Sort x Diameter Bin Summary

Sp	Bin	Status	Sort	Dia	Len	BF Net	Defect %	Tons	MBF Net
BC	12 - 15	LIVE	Domestic	12.6	20	9	0.0	9.1	1.3
BC	16 - 19	LIVE	Domestic	18.7	40	48	0.0	44.3	7.1
DF	5 - 7	LIVE	Domestic	6.8	28	551	2.8	708.0	80.6
DF	8 - 11	LIVE	Pole	9.4	32	323	0.0	367.0	47.2
DF	8 - 11	LIVE	Domestic	9.9	33	3,469	1.4	4,030.7	507.6
DF	12 - 15	LIVE	Domestic	13.8	37	4,524	1.1	4,428.8	661.8
DF	12 - 15	LIVE	Pole	13.9	40	519	1.2	558.1	75.9
DF	12 - 15	LIVE	HQ-A	14.2	38	945	0.0	946.5	138.2
DF	12 - 15	LIVE	HQ-B	14.7	40	342	0.0	328.6	50.1
DF	16 - 19	LIVE	HQ-B	17.5	40	1,373	1.1	1,220.5	200.8
DF	16 - 19	LIVE	Domestic	17.6	39	5,033	1.9	4,381.0	736.3
DF	16 - 19	LIVE	HQ-A	17.6	39	1,290	1.4	1,156.2	188.7
DF	16 - 19	LIVE	Cull	18.8	7	0	100.0	0.0	0.0
DF	20+	LIVE	Cull	20.0	6	0	100.0	0.0	0.0
DF	20+	LIVE	HQ-A	21.3	39	864	1.3	720.1	126.5
DF	20+	LIVE	Domestic	22.4	39	5,520	2.9	4,480.9	807.6
DF	20+	LIVE	HQ-B	22.7	39	1,043	0.0	801.9	152.6
MA	5+	LIVE	Pulp	8.7	22	58	0.0	58.9	8.4
MA	5+	LIVE	Domestic	10.6	21	425	1.9	400.0	62.1
RC	5+	LIVE	Domestic	9.0	30	909	2.4	1,144.2	133.0
RC	5+	LIVE	Pole	11.0	34	582	0.0	621.4	85.1

Sp	Bin	Status	Sort	Dia	Len	BF Net	Defect %	Tons	MBF Net
RC	5+	LIVE	Cull	13.8	8	0	100.0	0.0	0.0
WH	5 - 7	LIVE	Pulp	5.9	27	133	0.0	176.1	19.5
WH	5 - 7	LIVE	Domestic	6.5	29	1,634	0.2	2,390.7	239.0
WH	8 - 11	LIVE	Domestic	9.8	35	5,033	0.9	6,479.2	736.3
WH	8 - 11	LIVE	Pulp	10.8	37	225	0.0	251.6	32.9
WH	12 - 15	LIVE	Pulp	12.2	26	20	0.0	21.2	2.9
WH	12 - 15	LIVE	Domestic	13.5	38	6,052	0.5	7,053.2	885.5
WH	16 - 19	LIVE	Cull	17.4	5	0	100.0	0.0	0.0
WH	16 - 19	LIVE	Domestic	17.6	39	3,122	1.3	3,155.5	456.8
WH	20+	LIVE	Domestic	23.5	40	1,081	3.8	986.8	158.1
WH	20+	LIVE	Cull	24.2	6	0	100.0	0.0	0.0

Cruise Unit Report RIDGE ENDER U1

Unit Sale Notice Volume (MBF): RIDGE ENDER U1

Sp	DBH	Rings/In	Age	MBF Volume by Grade				
				All	Spec Mill	2 Saw	3 Saw	4 Saw
DF	20.5	10.0		477	18	303	147	9
WH	15.4			57		15	37	4
MA	13.0			28		3	18	7
RC	28.9			10			10	0
BC	29.3			8		8		
ALL	18.6	10.0		580	18	330	211	20

Unit Cruise Design: RIDGE ENDER U1

Design	Cruise Acres	FMA Acres	N Plots	N Cruise Plots	N Void Plots
B2: VR, 2 BAF (54.44, 40 for some species) Measure All, Sighting Ht = 4.5 ft	20.6	22.8	18	18	0

Unit Cruise Summary: RIDGE ENDER U1

Sp	Cruised Trees	All Trees	Trees/Plot	Ring-Count Trees
DF	50	50	2.8	1
WH	7	7	0.4	0
MA	4	9	0.5	0
RC	2	2	0.1	0
BC	1	1	0.1	0
ALL	64	69	3.8	1

Unit Cruise Statistics: RIDGE ENDER U1

Sp	BA (sq ft/acre)	BA CV (%)	BA SE (%)	V-BAR (bf/sq ft)	V-BAR CV (%)	V-BAR SE (%)	Net Vol (bf/acre)	Vol CV (%)	Vol SE (%)
DF	151.2	73.6	17.4	153.3	24.5	3.5	23,179	77.6	17.7
WH	21.2	156.3	36.8	129.7	28.1	10.6	2,745	158.8	38.3
MA	20.0	249.7	58.9	66.9	21.5	10.8	1,338	250.6	59.8
RC	4.4	424.3	100.0	109.1	11.5	8.1	485	424.4	100.3
BC	3.0	424.3	100.0	134.6	0.0	0.0	407	424.3	100.0
ALL	199.9	51.4	12.1	140.9	30.1	3.8	28,155	59.6	12.7

Unit Summary: RIDGE ENDER U1

Sp	Status	Rx	N	D	DBH	BL	THT	BF Gross	BF Net	Defect %	TPA	BA	RD	MBF Net
BC	LIVE	CUT	1	ALL	29.3	70	86	407	407	0.0	0.6	3.0	0.6	8.4
DF	LIVE	CUT	50	ALL	20.5	80	103	23,713	23,179	2.3	66.0	151.2	33.4	477.5
MA	LIVE	CUT	4	ALL	13.0	47	56	1,338	1,338	0.0	21.7	20.0	5.5	27.6
RC	LIVE	CUT	2	ALL	28.9	80	93	502	485	3.5	1.0	4.4	0.8	10.0
WH	LIVE	CUT	7	ALL	15.4	65	81	2,745	2,745	0.0	16.4	21.2	5.4	56.5
ALL	LIVE	CUT	64	ALL	18.6	71	90	28,706	28,155	1.9	105.7	199.9	45.7	580.0
ALL	ALL	ALL	64	ALL	18.6	71	90	28,706	28,155	1.9	105.7	199.9	45.7	580.0

DRAFT

Cruise Unit Report RIDGE ENDER U2

Unit Sale Notice Volume (MBF): RIDGE ENDER U2

Sp	DBH	Rings/In	Age	MBF Volume by Grade					
				All	Spec Mill	2 Saw	3 Saw	4 Saw	Utility
WH	16.2			449		184	235	28	2
DF	23.9			176	15	126	32	3	
RC	15.4			8			7	1	
ALL	17.2			632	15	310	274	31	2

Unit Cruise Design: RIDGE ENDER U2

Design	Cruise Acres	FMA Acres	N Plots	N Cruise Plots	N Void Plots
B2: VR, 2 BAF (54.44, 40 for some species) Measure All, Sighting Ht = 4.5 ft	16.2	17.4	14	14	0

Unit Cruise Summary: RIDGE ENDER U2

Sp	Cruised Trees	All Trees	Trees/Plot	Ring-Count Trees
WH	48	48	3.4	0
DF	14	14	1.0	0
RC	2	2	0.1	0
ALL	64	64	4.6	0

Unit Cruise Statistics: RIDGE ENDER U2

Sp	BA (sq ft/acre)	BA CV (%)	BA SE (%)	V-BAR (bf/sq ft)	V-BAR CV (%)	V-BAR SE (%)	Net Vol (bf/acre)	Vol CV (%)	Vol SE (%)
WH	186.7	60.2	16.1	148.5	22.3	3.2	27,720	64.2	16.4
DF	54.4	156.9	41.9	199.4	20.2	5.4	10,854	158.2	42.3
RC	6.7	257.6	68.9	69.1	22.2	15.7	466	258.6	70.6
ALL	247.8	39.4	10.5	157.5	27.4	3.4	39,040	48.0	11.1

Unit Summary: RIDGE ENDER U2

Sp	Status	Rx	N	D	DBH	BL	THT	BF Gross	BF Net	Defect %	TPA	BA	RD	MBF Net
DF	LIVE	CUT	14	ALL	23.9	97	124	10,877	10,854	0.2	17.5	54.4	11.1	175.8
RC	LIVE	CUT	2	ALL	15.4	55	69	466	466	0.0	5.2	6.7	1.7	7.5

Sp	Status	Rx	N	D	DBH	BL	THT	BF Gross	BF Net	Defect %	TPA	BA	RD	MBF Net
WH	LIVE	CUT	48	ALL	16.2	72	91	27,948	27,720	0.8	130.4	186.7	46.4	449.1
ALL	LIVE	CUT	64	ALL	17.2	75	94	39,291	39,040	0.6	153.1	247.8	59.2	632.5
ALL	ALL	ALL	64	ALL	17.2	75	94	39,291	39,040	0.6	153.1	247.8	59.2	632.5

DRAFT

Cruise Unit Report RIDGE ENDER U3

Unit Sale Notice Volume (MBF): RIDGE ENDER U3

Sp	DBH	Rings/In	Age	MBF Volume by Grade				
				All	Spec Mill	2 Saw	3 Saw	4 Saw
WH	17.7			225		107	110	8
DF	19.7			108	10	59	38	
RC	27.3			5			5	
ALL	18.4			337	10	166	153	8

Unit Cruise Design: RIDGE ENDER U3

Design	Cruise Acres	FMA Acres	N Plots	N Cruise Plots	N Void Plots
B2: VR, 2 BAF (62.5, 40 for some species) Measure All, Sighting Ht = 4.5 ft	9.9	11.7	8	8	0

Unit Cruise Summary: RIDGE ENDER U3

Sp	Cruised Trees	All Trees	Trees/Plot	Ring-Count Trees
WH	20	20	2.5	0
DF	8	9	1.1	0
RC	1	1	0.1	0
ALL	29	30	3.8	0

Unit Cruise Statistics: RIDGE ENDER U3

Sp	BA (sq ft/acre)	BA CV (%)	BA SE (%)	V-BAR (bf/sq ft)	V-BAR CV (%)	V-BAR SE (%)	Net Vol (bf/acre)	Vol CV (%)	Vol SE (%)
WH	156.3	52.4	18.5	145.2	12.2	2.7	22,688	53.8	18.7
DF	70.3	129.6	45.8	154.5	29.1	10.3	10,862	132.8	47.0
RC	5.0	282.8	100.0	108.0	0.0	0.0	540	282.8	100.0
ALL	231.6	30.4	10.7	147.2	18.9	3.5	34,090	35.8	11.3

Unit Summary: RIDGE ENDER U3

Sp	Status	Rx	N	D	DBH	BL	THT	BF Gross	BF Net	Defect %	TPA	BA	RD	MBF Net
DF	LIVE	CUT	8	ALL	19.7	76	98	10,960	10,862	0.9	33.2	70.3	15.8	107.5
RC	LIVE	CUT	1	ALL	27.3	80	102	589	540	8.4	1.2	5.0	1.0	5.3

Sp	Status	Rx	N	D	DBH	BL	THT	BF Gross	BF Net	Defect %	TPA	BA	RD	MBF Net
WH	LIVE	CUT	20	ALL	17.7	78	97	23,095	22,688	1.8	91.4	156.3	37.1	224.6
ALL	LIVE	CUT	29	ALL	18.4	77	97	34,644	34,090	1.6	125.8	231.6	53.9	337.5
ALL	ALL	ALL	29	ALL	18.4	77	97	34,644	34,090	1.6	125.8	231.6	53.9	337.5

DRAFT

Cruise Unit Report RIDGE ENDER U4

Unit Sale Notice Volume (MBF): RIDGE ENDER U4

Sp	DBH	Rings/In	Age	MBF Volume by Grade					
				All	Spec Mill	2 Saw	3 Saw	4 Saw	Utility
DF	24.8	12.0		2,645	223	2,065	330	26	
WH	19.0			1,341		885	385	25	45
RC	20.3			184			173	10	
MA	17.8			43		28	6		8
ALL	22.0	12.0		4,212	223	2,978	895	62	54

Unit Cruise Design: RIDGE ENDER U4

Design	Cruise Acres	FMA Acres	N Plots	N Cruise Plots	N Void Plots
B2C: VR, 2 BAF (54.44, 40 for some species) Measure/Count Plots, Sighting Ht = 4.5 ft	79.6	85.9	46	24	1

Unit Cruise Summary: RIDGE ENDER U4

Sp	Cruised Trees	All Trees	Trees/Plot	Ring-Count Trees
DF	74	124	2.7	1
WH	36	85	1.8	0
RC	13	26	0.6	0
MA	5	6	0.1	0
ALL	128	241	5.2	1

Unit Cruise Statistics: RIDGE ENDER U4

Sp	BA (sq ft/acre)	BA CV (%)	BA SE (%)	V-BAR (bf/sq ft)	V-BAR CV (%)	V-BAR SE (%)	Net Vol (bf/acre)	Vol CV (%)	Vol SE (%)
DF	146.8	81.6	12.0	226.4	20.9	2.4	33,223	84.2	12.3
WH	100.6	122.9	18.1	167.5	22.7	3.8	16,845	124.9	18.5
RC	22.6	222.7	32.8	102.2	34.1	9.5	2,310	225.3	34.2
MA	5.2	261.1	38.5	103.6	28.5	12.7	540	262.6	40.5
ALL	275.2	37.6	5.5	192.3	32.1	2.8	52,918	49.4	6.2

Unit Summary: RIDGE ENDER U4

Sp	Status	Rx	N	D	DBH	BL	THT	BF Gross	BF Net	Defect %	TPA	BA	RD	MBF Net
DF	LIVE	CUT	74	ALL	24.8	103	134	33,837	33,223	1.8	43.7	146.8	29.5	2,644.6
MA	LIVE	CUT	5	ALL	17.8	65	79	556	540	2.7	3.0	5.2	1.2	43.0
RC	LIVE	CUT	13	ALL	20.3	73	93	2,393	2,310	3.5	10.1	22.6	5.0	183.9
WH	LIVE	CUT	36	ALL	19.0	82	104	17,177	16,845	1.9	51.1	100.6	23.1	1,340.8
ALL	LIVE	CUT	128	ALL	21.6	89	114	53,962	52,918	1.9	107.9	275.2	58.8	4,212.3
ALL	ALL	ALL	128	ALL	21.6	89	114	53,962	52,918	1.9	107.9	275.2	58.8	4,212.3

Cruise Unit Report RIDGE ENDER U5A

Unit Sale Notice Volume (MBF): RIDGE ENDER U5A

Sp	DBH	Rings/In	Age	MBF Volume by Grade				
				All	2 Saw	3 Saw	4 Saw	Utility
WH	21.0			269	195	68	1	5
DF	30.0			94	88	4	1	
RC	27.2			10		10	1	
ALL	22.4			373	283	82	3	5

Unit Cruise Design: RIDGE ENDER U5A

Design	Cruise Acres	FMA Acres	N Plots	N Cruise Plots	N Void Plots
B2: VR, 2 BAF (54.44, 40 for some species) Measure All, Sighting Ht = 4.5 ft	7.7	8.3	4	4	0

Unit Cruise Summary: RIDGE ENDER U5A

Sp	Cruised Trees	All Trees	Trees/Plot	Ring-Count Trees
WH	14	14	3.5	0
DF	4	4	1.0	0
RC	1	1	0.3	0
ALL	19	19	4.8	0

Unit Cruise Statistics: RIDGE ENDER U5A

Sp	BA (sq ft/acre)	BA CV (%)	BA SE (%)	V-BAR (bf/sq ft)	V-BAR CV (%)	V-BAR SE (%)	Net Vol (bf/acre)	Vol CV (%)	Vol SE (%)
WH	190.5	54.7	27.4	183.3	16.5	4.4	34,918	57.2	27.7
DF	54.4	81.6	40.8	223.8	11.0	5.5	12,185	82.4	41.2
RC	10.0	200.0	100.0	136.0	0.0	0.0	1,360	200.0	100.0
ALL	255.0	39.3	19.6	190.1	18.3	4.2	48,464	43.3	20.1

Unit Summary: RIDGE ENDER U5A

Sp	Status	Rx	N	D	DBH	BL	THT	BF Gross	BF Net	Defect %	TPA	BA	RD	MBF Net
DF	LIVE	CUT	4	ALL	30.0	112	144	12,664	12,185	3.8	11.1	54.4	9.9	93.8
RC	LIVE	CUT	1	ALL	27.2	80	102	1,360	1,360	0.0	2.5	10.0	1.9	10.5

Sp	Status	Rx	N	D	DBH	BL	THT	BF Gross	BF Net	Defect %	TPA	BA	RD	MBF Net
WH	LIVE	CUT	14	ALL	21.0	88	111	35,790	34,918	2.4	79.2	190.5	41.6	268.9
ALL	LIVE	CUT	19	ALL	22.4	91	115	49,814	48,464	2.7	92.8	255.0	53.4	373.2
ALL	ALL	ALL	19	ALL	22.4	91	115	49,814	48,464	2.7	92.8	255.0	53.4	373.2

DRAFT

Cruise Unit Report RIDGE ENDER U5B

Unit Sale Notice Volume (MBF): RIDGE ENDER U5B

Sp	DBH	Rings/In	Age	MBF Volume by Grade			
				All	2 Saw	3 Saw	4 Saw
WH	22.6			2	2	1	0
ALL	22.6			2	2	1	0

Unit Cruise Design: RIDGE ENDER U5B

Design	Cruise Acres	FMA Acres	N Plots	N Cruise Plots	N Void Plots
B1: VR, 1 BAF (54.44) Measure All, Sighting Ht = 4.5 ft	0.1	0.1	2	2	0

Unit Cruise Summary: RIDGE ENDER U5B

Sp	Cruised Trees	All Trees	Trees/Plot	Ring-Count Trees
WH	5	5	2.5	0
ALL	5	5	2.5	0

Unit Cruise Statistics: RIDGE ENDER U5B

Sp	BA (sq ft/acre)	BA CV (%)	BA SE (%)	V-BAR (bf/sq ft)	V-BAR CV (%)	V-BAR SE (%)	Net Vol (bf/acre)	Vol CV (%)	Vol SE (%)
WH	136.1	28.3	20.0	181.3	25.4	11.4	24,671	38.0	23.0
ALL	136.1	28.3	20.0	181.3	25.4	11.4	24,671	38.0	23.0

Unit Summary: RIDGE ENDER U5B

Sp	Status	Rx	N	D	DBH	BL	THT	BF Gross	BF Net	Defect %	TPA	BA	RD	MBF Net
WH	LIVE	CUT	5	ALL	22.6	84	105	26,085	24,671	5.4	48.9	136.1	28.6	2.5
ALL	LIVE	CUT	5	ALL	22.6	84	105	26,085	24,671	5.4	48.9	136.1	28.6	2.5
ALL	ALL	ALL	5	ALL	22.6	84	105	26,085	24,671	5.4	48.9	136.1	28.6	2.5

Cruise Unit Report RIDGE ENDER U5C

Unit Sale Notice Volume (MBF): RIDGE ENDER U5C

Sp	DBH	Rings/In	Age	MBF Volume by Grade			
				All	2 Saw	3 Saw	4 Saw
DF	24.5			244	202	41	2
WH	21.8			60	49	10	1
ALL	23.9			304	250	50	4

Unit Cruise Design: RIDGE ENDER U5C

Design	Cruise Acres	FMA Acres	N Plots	N Cruise Plots	N Void Plots
B2: VR, 2 BAF (54.44, 40 for some species) Measure All, Sighting Ht = 4.5 ft	8.1	8.7	4	4	0

Unit Cruise Summary: RIDGE ENDER U5C

Sp	Cruised Trees	All Trees	Trees/Plot	Ring-Count Trees
DF	11	11	2.8	0
WH	3	3	0.8	0
ALL	14	14	3.5	0

Unit Cruise Statistics: RIDGE ENDER U5C

Sp	BA (sq ft/acre)	BA CV (%)	BA SE (%)	V-BAR (bf/sq ft)	V-BAR CV (%)	V-BAR SE (%)	Net Vol (bf/acre)	Vol CV (%)	Vol SE (%)
DF	149.7	34.8	17.4	201.6	20.6	6.2	30,179	40.4	18.5
WH	40.8	66.7	33.3	179.9	18.9	10.9	7,347	69.3	35.1
ALL	190.5	36.9	18.4	196.9	20.2	5.4	37,527	42.1	19.2

Unit Summary: RIDGE ENDER U5C

Sp	Status	Rx	N	D	DBH	BL	THT	BF Gross	BF Net	Defect %	TPA	BA	RD	MBF Net
DF	LIVE	CUT	11	ALL	24.5	99	126	30,416	30,179	0.8	45.7	149.7	30.2	244.5
WH	LIVE	CUT	3	ALL	21.8	91	115	7,347	7,347	0.0	15.8	40.8	8.7	59.5
ALL	LIVE	CUT	14	ALL	23.8	97	123	37,763	37,527	0.6	61.5	190.5	39.0	304.0
ALL	ALL	ALL	14	ALL	23.8	97	123	37,763	37,527	0.6	61.5	190.5	39.0	304.0

Cruise Unit Report RIDGE ENDER ROW 1

Unit Sale Notice Volume (MBF): RIDGE ENDER ROW 1

Sp	DBH	Rings/In	Age	MBF Volume by Grade					
				All	Spec Mill	2 Saw	3 Saw	4 Saw	Utility
WH	16.5			129		64	55	7	3
DF	28.4			30	4	24	2		
RC	20.2			1			1		
ALL	17.3			160	4	88	58	7	3

Unit Cruise Design: RIDGE ENDER ROW 1

Design	Cruise Acres	FMA Acres	N Plots	N Cruise Plots	N Void Plots
B2C: VR, 2 BAF (54.44, 40 for some species) Measure/Count Plots, Sighting Ht = 4.5 ft	4.1	4.1	7	7	0

Unit Cruise Summary: RIDGE ENDER ROW 1

Sp	Cruised Trees	All Trees	Trees/Plot	Ring-Count Trees
WH	26	26	3.7	0
DF	4	4	0.6	0
RC	1	1	0.1	0
ALL	31	31	4.4	0

Unit Cruise Statistics: RIDGE ENDER ROW 1

Sp	BA (sq ft/acre)	BA CV (%)	BA SE (%)	V-BAR (bf/sq ft)	V-BAR CV (%)	V-BAR SE (%)	Net Vol (bf/acre)	Vol CV (%)	Vol SE (%)
WH	202.2	53.2	20.1	155.7	18.9	3.7	31,493	56.5	20.4
DF	31.1	93.5	35.4	236.7	4.9	2.5	7,364	93.7	35.4
RC	5.7	264.6	100.0	39.5	0.0	0.0	226	264.6	100.0
ALL	239.0	42.1	15.9	163.5	27.5	4.9	39,082	50.3	16.7

Unit Summary: RIDGE ENDER ROW 1

Sp	Status	Rx	N	D	DBH	BL	THT	BF Gross	BF Net	Defect %	TPA	BA	RD	MBF Net
DF	LIVE	CUT	4	ALL	28.4	114	147	7,548	7,364	2.4	7.1	31.1	5.8	30.2
RC	LIVE	CUT	1	ALL	20.2	50	62	226	226	0.0	2.6	5.7	1.3	0.9

Sp	Status	Rx	N	D	DBH	BL	THT	BF Gross	BF Net	Defect %	TPA	BA	RD	MBF Net
WH	LIVE	CUT	26	ALL	16.5	74	94	31,493	31,493	0.0	136.2	202.2	49.8	129.1
ALL	LIVE	CUT	31	ALL	17.3	76	96	39,266	39,082	0.5	145.9	239.0	56.9	160.2
ALL	ALL	ALL	31	ALL	17.3	76	96	39,266	39,082	0.5	145.9	239.0	56.9	160.2

DRAFT

Ridge Ender

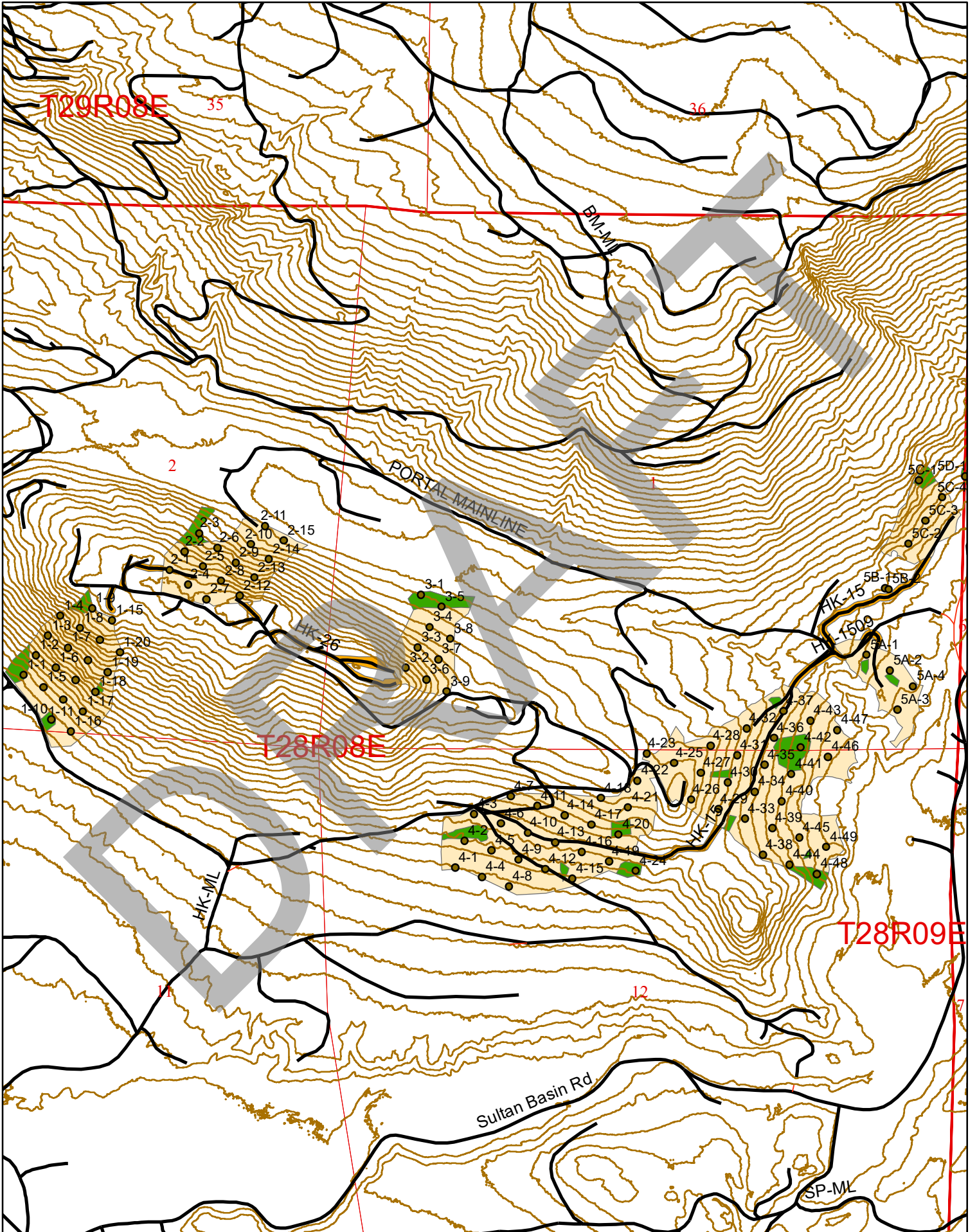



WASHINGTON STATE
DEPT. OF NATURAL RESOURCES
NORTHWEST REGION

ROAD PLAN AND SPECIFICATIONS

#30-104444 RIDGE ENDER TIMBER SALE

LEGEND	
PRE-HAUL MAINTENANCE	-----
REQUIRED CONSTRUCTION	-----
OPTIONAL CONSTRUCTION	-----
REQUIRED RECONSTRUCTION	=====
OPTIONAL RECONSTRUCTION	=====

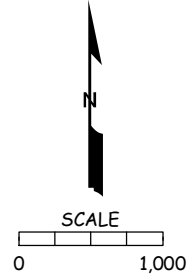
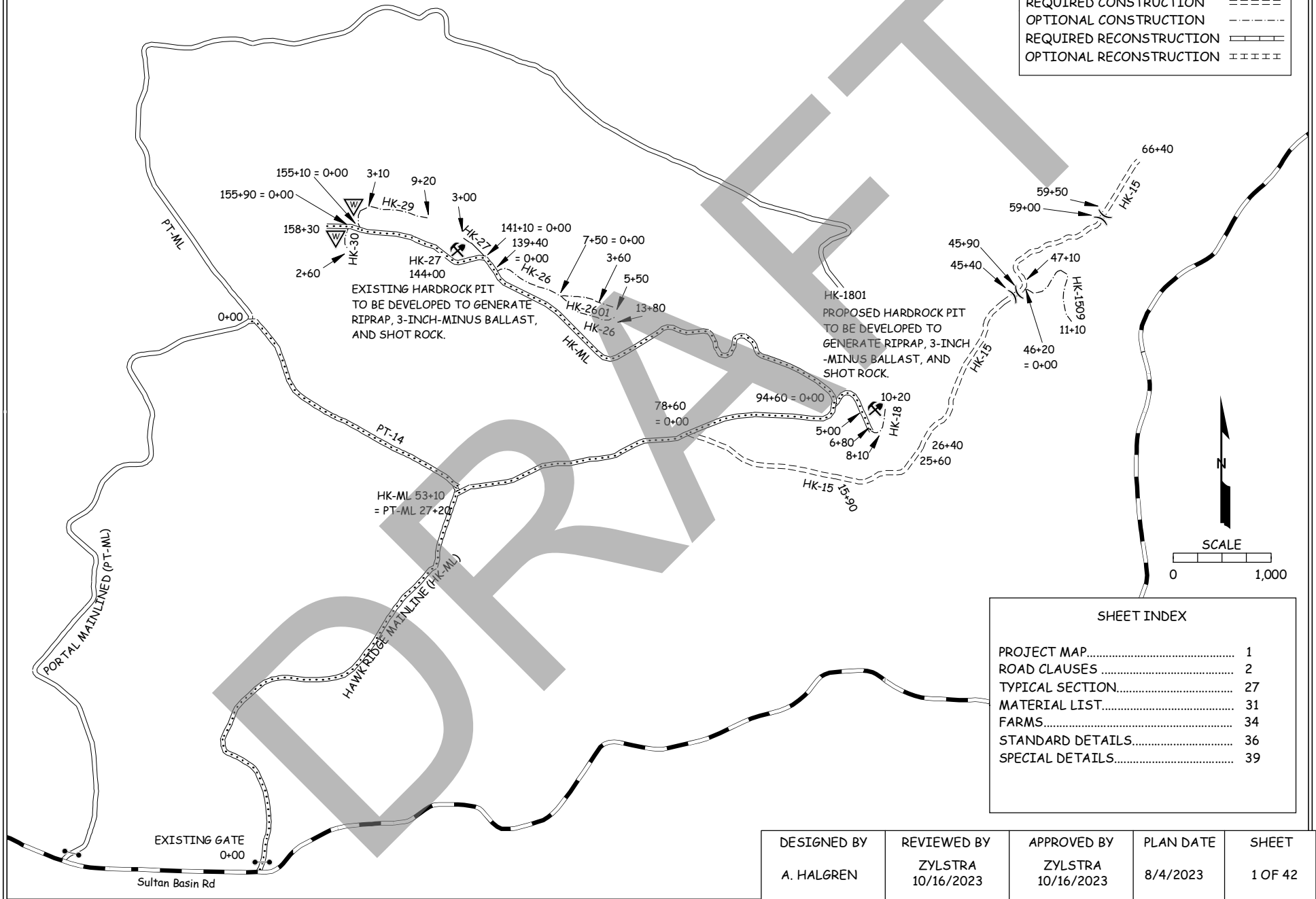

SHEET INDEX	
PROJECT MAP.....	1
ROAD CLAUSES	2
TYPICAL SECTION.....	27
MATERIAL LIST.....	31
FARMS.....	34
STANDARD DETAILS.....	36
SPECIAL DETAILS.....	39

DESIGNED BY	REVIEWED BY	APPROVED BY	PLAN DATE	SHEET
A. HALGREN	ZYLSTRA 10/16/2023	ZYLSTRA 10/16/2023	8/4/2023	1 OF 42

STATE OF WASHINGTON
DEPARTMENT OF NATURAL RESOURCES

RIDGE ENDER TIMBER SALE ROAD PLAN
SNOHOMISH COUNTY
CASCADE DISTRICT
NORTHWEST REGION

AGREEMENT NO.:30-104444

STAFF ENGINEER: A. HALGREN

DATE: AUGUST 4, 2023

SECTION 0 – SCOPE OF PROJECT

0-1 ROAD PLAN SCOPE

Clauses in this road plan apply to all road related work, including landings and rock source development, unless otherwise noted.

0-2 REQUIRED ROADS

The specified work on the following roads is required.

<u>Road</u>	<u>Stations</u>	<u>Type</u>
HK-ML	0+00 TO 158+30	MAINTENANCE
PT-14	0+00 TO 53+10	MAINTENANCE
HK-15	0+00 TO 66+40	CONSTRUCTION
HK-18	0+00 TO 6+80	MAINTENANCE

0-3 OPTIONAL ROADS

The specified work on the following roads is not required. Any optional roads built by the Purchaser must meet all the specifications in the road plan.

<u>Road</u>	<u>Stations</u>	<u>Type</u>
HK-1509	0+00 to 11+10	CONSTRUCTION
HK-18*	6+80 TO 10+20	CONSTRUCTION
HK-26	0+00 TO 13+80	CONSTRUCTION
HK-2601	0+00 TO 5+50	CONSTRUCTION
HK-27	0+00 TO 3+00	CONSTRUCTION
HK-29	0+00 TO 9+20	CONSTRUCTION
HK-30	0+00 to 2+60	CONSTRUCTION

*Not to be abandoned if built

0-4 CONSTRUCTION

Construction includes, but is not limited to clearing, grubbing, excavation and embankment to sub-grade, full bench sidecast, full bench end-haul, landing and turnout construction, culvert installation, geotextile installation, steel modular bridge installation, drill and shoot, gate installation, application of 3-inch-minus ballast rock, and application of Shot Rock.

0-5 RECONSTRUCTION

Reconstruction includes, but is not limited to blading, shaping, and ditching the road surface, brushing, clearing, grubbing, culvert installation, application of 3-inch-minus ballast rock, and application of Shot Rock.

0-6 PRE-HAUL MAINTENANCE

Pre-haul maintenance includes, but is not limited to brushing.

0-7 POST-HAUL MAINTENANCE

This project includes post-haul road maintenance listed in Clause 9-5 POST-HAUL MAINTENANCE.

0-10 ABANDONMENT

This project includes abandonment listed in Clause 9-21 ROAD ABANDONMENT.

0-12 DEVELOP ROCK SOURCE

Purchaser may develop new rock sources. Rock source development will involve clearing, stripping, drilling, shooting, and processing rock to generate riprap, 3-inch-minus ballast or surfacing. Work for developing rock sources is listed in Section 6 ROCK AND SURFACING.

0-13 STRUCTURES

Contractor shall provide and install two bridges with minimum dimensions of 50 foot span and 14 foot width. Requirements for these structures are listed in Section 7 STRUCTURES.

SECTION 1 – GENERAL

1-1 ROAD PLAN CHANGES

If the Purchaser desires a change from this road plan including, but not limited to, relocation, extension, change in design, or adding roads; a revised road plan must be submitted in writing to the Contract Administrator for consideration. Before work begins, Purchaser shall obtain approval from the State for any submitted plan that changes the scope of work or environmental condition from the original road plan.

1-2 UNFORESEEN CONDITIONS

Quantities established in this road plan are minimum acceptable values. Additional quantities required by the state due to unforeseen conditions, or Purchaser's choice of construction season or techniques will be at the Purchaser's expense. Unforeseen conditions include, but are not limited to, solid subsurface rock, subsurface springs, saturated ground, and unstable soils.

1-3 ROAD DIMENSIONS

Purchaser shall perform road work in accordance with the dimensions shown on the TYPICAL SECTION SHEET and the specifications within this road plan.

1-4 ROAD TOLERANCES

Contractor shall perform road work within the tolerances listed below. The tolerance class for each road is listed on the TYPICAL SECTION SHEET.

<u>Tolerance Class</u>	<u>A</u>	<u>B</u>	<u>C</u>
Road and Subgrade Width (feet)	+1.5	+1.5	+2.0
Subgrade Elevation (feet +/-)	0.5	1.0	2.0
Centerline alignment (feet lt./rt.)	1.0	1.5	3.0
Bridge Elevation (feet)	±0.25		

1-5 DESIGN DATA

Switchback design data is available upon request at the Department of Natural Resources Northwest Region Office in Sedro Woolley, WA.

1-6 ORDER OF PRECEDENCE

Any conflict or inconsistency in the road plan will be resolved by giving the documents precedence in the following order:

1. Addenda.
2. Designs or Plans. On designs and plans, figured dimensions shall take precedence over scaled dimensions.
3. Road Plan Clauses.
4. Typical Section Sheet.
5. Standard Lists.
6. Standard Details.
7. Road Plan maps.

In case of any ambiguity or dispute over interpreting the road plan, the Contract Administrator's or designee's decision will be final.

1-8 REPAIR OR REPLACEMENT OF DAMAGED MATERIALS

Purchaser shall repair or replace all materials, roadway infrastructure, and road components damaged during road work or operation activities. The Contract Administrator will direct repairs and replacements. Repairs to structural materials must be made in accordance with the manufacturer’s recommendation, and may not begin without written approval from the Contract Administrator.

1-9 DAMAGED METALLIC COATING

Any cut ends, or damaged galvanized or aluminized coating on existing or new bridge components, culverts, downspouts, and flumes must be cleaned and treated with a minimum of two coats of zinc rich paint or cold galvanizing compound.

1-16 CONSTRUCTION STAKES SET BY STATE

Purchaser shall perform work on the following road(s) in accordance with the construction stakes and reference points set in the field for grade and alignment.

<u>Road</u>	<u>Stations</u>	<u>Type</u>
HK-15	45+00 TO 46+50	BRIDGE STAKING
HK-15	58+50 TO 60+00	BRIDGE STAKING

1-18 REFERENCE POINT DAMAGE

Purchaser shall reset reference points (RPs) that were moved or damaged at any time during construction to their original locations. Excavation and embankment may not proceed on road segments controlled by said RPs until Purchaser resets all moved or damaged RPs.

1-21 HAUL APPROVAL

Purchaser shall not use roads under this road plan for any hauling other than timber cut on the right-of-way, without written approval from the Contract Administrator.

1-22 WORK NOTIFICATIONS

On the following road(s), Purchaser shall notify the Contract Administrator a minimum of 7 calendar days BUT NOT MORE THAN 30 DAYS before work begins.

<u>Road</u>	<u>Stations</u>
HK-15	45+00 TO 46+50
HK-15	58+50 TO 60+00

1-25 ACTIVITY TIMING RESTRICTION

The specified activities are not allowed during the listed closure period(s) unless authorized in writing by the Contract Administrator.

<u>Road</u>	<u>Stations</u>	<u>Activity</u>	<u>Closure Period</u>
ALL		Rock hauling, construction, reconstruction, or abandonment	November 1 to March 31
HK-15	45+00 TO 46+50 58+50 TO 60+00	In-streamwork	*September 30 to June 15

*Not waivable

1-26 OPERATING DURING CLOSURE PERIOD

If permission is granted to operate during a closure period listed in Clause 1-25 ACTIVITY TIMING RESTRICTION, Purchaser shall provide a maintenance plan to include further protection of state resources. Purchaser shall obtain written approval from the Contract Administrator for the maintenance plan, and shall put preventative measures in place before operating during the closure period. Purchaser is required to maintain all haul roads at their own expense including those listed in Contract Clause C-060 DESIGNATED ROAD MAINTAINER. If other operators are using, or desire to use these designated maintainer roads, a joint operating plan must be developed. All parties shall follow this plan.

1-29 SEDIMENT RESTRICTION

Purchaser shall not allow silt-bearing runoff to enter any streams.

1-30 CLOSURE TO PREVENT DAMAGE

In accordance with Contract Clause G-220 STATE SUSPENDS OPERATION, the Contract Administrator will suspend road work or hauling right-of-way timber, forest products, or rock under the following conditions:

- Wheel track rutting exceeds 4 inches on crushed rock roads.
- Surface or base stability problems persist.
- Weather is such that satisfactory results cannot be obtained in an area of operations.
- When, in the opinion of the Contract Administrator excessive road damage or rutting may occur.

Operations must stop unless authority to continue working or hauling is granted in writing by the Contract Administrator. In the event that surface or base stability problems persist, Purchaser shall cease operations, or perform corrective maintenance or repairs, subject to specifications within this road plan. Before and during any suspension, Purchaser shall protect the work from damage or deterioration.

1-33 SNOW PLOWING RESTRICTION

Snowplowing will be allowed after the execution of a SNOW PLOWING AGREEMENT, which is available from the Contract Administrator upon request. If damage occurs while plowing, further permission to plow may be revoked by the Contract Administrator.

1-40 ROAD APPROACHES TO COUNTY ROADS AND STATE HIGHWAYS

Purchaser shall immediately remove any mud, dirt, rock, or other material tracked or spilled on to county roads and state highways.

If additional damage to the surface, signs, guardrails, etc. occurs then the damage will be repaired, at the Purchaser's expense, as directed by the Contract Administrator when authorized by the county or WSDOT.

SECTION 2 – MAINTENANCE

2-1 GENERAL ROAD MAINTENANCE

Purchaser shall maintain all roads used under this contract in accordance with the FOREST ACCESS ROAD MAINTENANCE SPECIFICATIONS for the entire term of this contract. Maintenance is required even during periods of inactivity.

2-2 ROAD MAINTENANCE – PURCHASER MAINTENANCE

Purchaser shall perform maintenance on roads listed in Contract Clause C-050 PURCHASER ROAD MAINTENANCE AND REPAIR in accordance with FOREST ACCESS ROAD MAINTENANCE SPECIFICATIONS.

SECTION 3 – CLEARING, GRUBBING, AND DISPOSAL

3-1 BRUSHING

On road(s) indicated in the Typical Section sheets, Purchaser shall cut vegetative material up to 6 inches in diameter, including limbs, as shown on the BRUSHING DETAIL. Brushing must be achieved by mechanical cutting of brush, trees, and branches. Root systems and stumps of cut vegetation may not be disturbed unless directed by the Contract Administrator. Purchaser shall remove brushing debris from the road surface, ditchlines, and culvert inlets and outlets.

3-5 CLEARING

Purchaser shall fall all vegetative material larger than 2 inches DBH or over 5 feet high between the marked right-of-way boundaries or if not marked in the field, between the clearing limits specified on the TYPICAL SECTION SHEET. Clearing must be completed before starting excavation and embankment.

3-6 CLEARING WITHIN RIPARIAN AREA AT TYPE 1-3 STREAM CROSSING

At the following stream crossing location(s), Purchaser shall place a log, with length equal to two (2) times the width of the ordinary high water, from the largest diameter class conifer tree cut from within the Inner Zone (25 feet either side of the stream) in the stream in accordance with the Riparian Forest Restoration Strategy. Additional logs shall be placed as described below:

<u>Road</u>	<u>Stations</u>	<u>Comments</u>
HK-15	45+00 TO 46+50	36.2' log segment minimum
HK-15	58+50 TO 60+00	Retain ALL trees cut from within the Inner Zone, up to 12 trees in total, and place downstream of the proposed bridge.

3-8 PROHIBITED DECKING AREAS

Purchaser shall not deck right-of-way timber in the following areas:

- Within the grubbing limits.
- Within 50 feet of any stream.
- In locations that interfere with the construction of the road prism.
- In locations that impede drainage.
- On slopes greater than 40%.
- Against standing trees.

3-10 GRUBBING

Purchaser shall remove all stumps between the grubbing limits specified on the TYPICAL SECTION SHEET and within waste and debris areas. Purchaser shall also remove stumps with undercut roots outside the grubbing limits. Grubbing must be completed before starting excavation and embankment.

3-11 GRUBBING WITHIN RIPARIAN AREA AT TYPE 1-3 STREAM CROSSING

At the following stream crossing location(s), Purchaser shall retain all grubbed stumps (root wads) within the Inner Zone (25 feet either side of the stream) for placement in accordance with the Riparian Forest Restoration Strategy. Three root wads must be placed in or adjacent to the stream channel. The remaining stumps grubbed from the Inner Zone must be placed at least 50 feet from the roadway in the Middle (25 feet to 100 feet from the stream) or the Outer Zones (remaining portion of RMZ).

<u>Road</u>	<u>Stations</u>
HK-15	45+00 TO 46+50
HK-15	58+50 TO 60+00

3-20 ORGANIC DEBRIS DEFINITION

Organic debris is defined as all vegetative material not eligible for removal by Contract Clause G-010 PRODUCTS SOLD AND SALE AREA or G-011 RIGHT TO REMOVE FOREST PRODUCTS AND CONTRACT AREA, that is larger than one cubic foot in volume within the clearing limits as shown on the TYPICAL SECTION SHEET.

3-21 DISPOSAL COMPLETION

Purchaser shall remove organic debris from the road surface, ditchlines, and culvert inlets and outlets. Purchaser shall complete all disposal of organic debris before the application of rock.

3-22 DESIGNATED WASTE AREA FOR ORGANIC DEBRIS

Waste areas for organic debris are located at areas approved in writing by the Contract Administrator.

3-23 PROHIBITED DISPOSAL AREAS

Purchaser shall not place organic debris in the following areas:

- Within 50 feet of a cross drain culvert.
- Within 100 feet of a live stream, or wetland
- On road subgrades, or excavation and embankment slopes.
- On slopes greater than 50%.
- Within the operational area for cable landings where debris may shift or roll.
- On locations where brush can fall into the ditch or onto the road surface.
- Against standing timber.

3-24 BURYING ORGANIC DEBRIS RESTRICTED

Purchaser shall not bury organic debris unless otherwise stated in this plan.

3-25 SCATTERING ORGANIC DEBRIS

Purchaser shall scatter organic debris outside of the clearing limits in natural openings unless otherwise detailed in this road plan.

SECTION 4 – EXCAVATION

4-2 PIONEERING

Pioneering may not extend past construction that will be completed during the current construction season. Pioneering may not extend more than 500 feet beyond completed construction unless approved in writing by the Contract Administrator. In addition, the following actions must be taken as pioneering progresses:

- Drainage must be provided on all uncompleted construction.
- Road pioneering operations may not undercut the final cut slope or restrict drainage.
- Culverts at live stream crossings must be installed during pioneering operations prior to embankment.

4-3 ROAD GRADE AND ALIGNMENT STANDARDS

Purchaser shall follow these standards for road grade and alignment:

- Grade and alignment must have smooth continuity, without abrupt changes in direction.
- Maximum grades may not exceed 18 percent favorable and 15 percent adverse.
- Minimum curve radius is 60 feet at centerline.
- Maximum grade change for sag vertical curves is 5% in 100 feet.
- Maximum grade change for crest vertical curves is 4% in 100 feet.

4-4 SWITCHBACK STANDARDS

A switchback is defined as a curved segment of road between a beginning and end of the same curve, where the change of traffic travel direction is greater than 90 degrees.

Purchaser shall follow these standards for switchbacks:

- Maximum adverse grades for switchbacks is 8%.
- Maximum favorable grades for switchbacks is 14% except as otherwise specified in clause 4-3 ROAD GRADE AND ALIGNMENT STANDARDS.
- Maximum transition grades entering and leaving switchbacks is a 6% grade change.
- Transition grades required to meet switchback grade limitations must be constructed on the tangents preceding and departing from the switchbacks.

4-5 CUT SLOPE RATIO

Purchaser shall construct excavation slopes no steeper than shown on the following table, unless construction staked or designed:

<u>Material Type</u>	<u>Excavation Slope Ratio</u>	<u>Excavation Slope Percent</u>
Common Earth (on side slopes up to 55%)	1:1	100
Common Earth (56% to 70% side slopes)	¾:1	133
Common Earth (on slopes over 70%)	½:1	200
Fractured or loose rock	½:1	200
Hardpan or solid rock	¼:1	400

4-6 EMBANKMENT SLOPE RATIO

Purchaser shall construct embankment slopes no steeper than shown on the following table, unless construction staked or designed:

<u>Material Type</u>	<u>Embankment Slope Ratio</u>	<u>Embankment Slope Percent</u>
Sandy Soils	2:1	50
Common Earth and Rounded Gravel	1½:1	67
Angular Rock	1¼:1	80

4-7 SHAPING CUT AND FILL SLOPE

Purchaser shall construct excavation and embankment slopes to a uniform line and left rough for easier revegetation.

4-8 CURVE WIDENING

The minimum widening placed on the inside of curves is:

- 6 feet for curves of 50 to 79 feet radius.
- 4 feet for curves of 80 to 100 feet radius.

4-9 EMBANKMENT WIDENING

The minimum embankment widening is:

- 2 feet for embankment heights at centerline of 2 to 6 feet.
- 4 feet for embankment heights at centerline of greater than 6 feet.

Purchaser shall apply embankment widening equally to both sides of the road to achieve the required width.

4-12 FULL BENCH CONSTRUCTION

On the following road(s), and where side slopes exceed 50% Purchaser shall use full bench construction for the entire subgrade width. If designated, Purchaser shall end haul waste material to the location specified in Clause 4-37 WASTE AREA LOCATION.

<u>Road</u>	<u>Full Bench Location</u>	<u>Comments</u>
HK-29	STA 4+90 TO 6+20, 7+00 TO 8+10	May require drill and shoot.

4-21 TURNOUTS

Purchaser shall construct turnouts intervisible with a maximum distance of 1,000 feet between turnouts unless otherwise shown on drawings. Locations may be adjusted to fit the final subgrade alignment and sight distances. Locations are subject to written approval by the Contract Administrator. Minimum dimensions are shown on the TYPICAL SECTION SHEET.

4-25 DITCH CONSTRUCTION AND RECONSTRUCTION

Purchaser shall construct or reconstruct ditches into the subgrade as specified on the TYPICAL SECTION SHEET. Ditches must be constructed concurrently with construction of the subgrade.

4-28 DITCH DRAINAGE

Ditches must drain to cross-drain culverts or ditchouts.

4-29 DITCHOUTS

Purchaser shall construct ditchouts as identified on the MATERIALS LIST and as needed or as directed or approved by the Contract Administrator. Ditchouts must be constructed in a manner that diverts ditch water onto the forest floor and must have excavation backslopes no steeper than a 1:1 ratio. Locations may not be changed without written approval from the Contract Administrator.

4-35 WASTE MATERIAL DEFINITION

Waste material is defined as all dirt, rock, mud, or related material that is extraneous or unsuitable for construction material. Waste material, as used in Section 4 EXCAVATION, is not organic debris.

4-36 DISPOSAL OF WASTE MATERIAL

Purchaser may sidecast waste material on side slopes up to 50% if the waste material is compacted and free of organic debris. On side slopes greater than 50%, all waste material must be end hauled or pushed to the designated embankment sites and waste areas identified in Clause 4-37 WASTE AREA LOCATION.

4-37 WASTE AREA LOCATION

Purchaser shall deposit waste material in the listed designated area(s). Additional waste areas may also be identified or approved by the Contract Administrator. The amount of material allowed in a waste area is at the discretion of the Contract Administrator unless listed below.

<u>Road</u>	<u>Waste Area Location</u>	<u>Volume (CY)</u>
HK-29	0+70 to 1+40	400
HK-30	0+50 to 1+50	600

4-38 PROHIBITED WASTE DISPOSAL AREAS

Purchaser shall not deposit waste material in the following areas, except as otherwise specified in this plan:

- Within 50 feet of a cross drain culvert.
- Within 100 feet of a live stream or wetland.
- Within a riparian management zone.
- On side slopes steeper than 50%.except as otherwise specified in this plan
- In locations that interfere with the construction of the road prism.
- In locations that impede drainage.
- Against standing timber.
- Outside the clearing limits.

4-55 ROAD SHAPING

Purchaser shall shape the subgrade and surface as shown on the TYPICAL SECTION SHEET. The subgrade and surface shape must ensure runoff in an even, un-concentrated manner, and must be uniform, firm, and rut-free.

4-60 FILL COMPACTION

Purchaser shall compact all embankment and waste material by routing equipment over the entire width of each lift.

4-61 SUBGRADE COMPACTION

Purchaser shall compact constructed and reconstructed subgrades by routing equipment over the entire width

4-70 SUBGRADE REINFORCEMENT

On the following road(s), Purchaser shall provide and install geotextile fabric. Subgrade reinforcement must be installed to a width that is 2 feet more than the subgrade width, including turnouts. Geotextile fabric must overlap by a minimum of 2 feet at all joints. The geotextile fabric must be covered with a minimum of 12 inches of compacted 3-inch-minus ballast rock. Purchaser shall apply rock in one-foot lift(s) over the geotextile in accordance with the manufacturer’s specifications. Geotextile fabric must meet the specifications in Clause 10-3 GEOTEXTILE FOR STABILIZATION.

<u>Road</u>	<u>Stations</u>
HK-15	61+30 to 63+70

SECTION 5 – DRAINAGE

5-5 CULVERTS

Purchaser shall install culverts as part of this contract. Culverts must be installed concurrently with subgrade work and must be installed before subgrade compaction and rock application. Culvert locations and the minimum requirements for culvert length and diameter are designated on the MATERIALS LIST. Culvert, downspout, and flume lengths may be adjusted to fit as-built conditions and may not terminate directly on unprotected soil. Culverts may be new or used material and must meet the specifications in Clauses 10-15 through 10-24.

5-7 USED CULVERT MATERIAL

Purchaser may install used culverts. Purchaser shall obtain approval from the Contract Administrator for the quality of the used culverts before installation. Culverts must meet the specifications in Clauses 10-15 through 10-24.

5-12 UNUSED MATERIALS STATE PROPERTY

On required roads, any materials listed on the MATERIALS LIST that are not installed will become the property of the state. Purchaser shall stockpile materials as directed by the Contract Administrator.

5-13 CONTINGENCY CULVERTS

The following culverts will be supplied by the Purchaser and are available for installation as directed by the Contract Administrator.

<u>Road</u>	<u>Size</u>	<u>Quantity</u>
On any portion of road used for timber or rock haul.	18" culvert band	8
	18" x 32' culvert	2
	18" x 36' culvert	4
	18" x 40' culvert	2
	24" culvert band	1
	24" x 36' culvert	1

5-15 CULVERT INSTALLATION

Culvert installation must be in accordance with the CULVERT AND DRAINAGE SPECIFICATION DETAIL and the National Corrugated Metal Pipe Association's "Installation Manual for Corrugated Steel Drainage Structures" and the Corrugated Polyethylene Pipe Association's "Recommended Installation Practices for Corrugated Polyethylene Pipe and Fittings".

5-16 APPROVAL FOR LARGER CULVERT INSTALLATION

Purchaser shall obtain written approval from the Contract Administrator for the installation of culverts 36 inches in diameter and over before backfilling.

5-17 CROSS DRAIN SKEW AND SLOPE

Cross drains, on road grades in excess of 3%, must be skewed at least 30 degrees from perpendicular to the road centerline, except where the cross drain is at the low point in the road culverts will not be skewed. Cross drain culverts must be installed at a slope steeper than the incoming ditch grade, but not less than 3% or more than 10%.

5-18 CULVERT DEPTH OF COVER

Cross drain culverts must be installed with a depth of cover of not less than 1 foot of compacted subgrade over the top of the culvert at the shallowest point. Stream crossing culverts must be installed with a depth of cover recommended by the culvert manufacturer for the type and size of the pipe.

5-20 ENERGY DISSIPATERS

Purchaser shall install energy dissipaters in accordance with the CULVERT AND DRAINAGE SPECIFICATION DETAIL. Energy dissipater installation is subject to approval by the Contract Administrator.

The type of energy dissipater and the amount of material must be consistent with the specifications listed on the CULVERT AND DRAINAGE SPECIFICATION DETAIL.

5-25 CATCH BASINS

Purchaser shall construct catch basins in accordance with CULVERT AND DRAINAGE SPECIFICATION DETAIL. Minimum dimensions of catch basins are 2 feet wide and 4 feet long.

5-26 HEADWALLS FOR CROSS DRAIN CULVERTS

Purchaser shall construct headwalls in accordance with the CULVERT AND DRAINAGE SPECIFICATION DETAIL at all cross drain culverts. Rock used for headwalls must weigh at least 50 pounds. Rock must be placed on shoulders, slopes, and around culvert inlets and outlets. Minimum specifications require that rock be placed at a width of one culvert diameter on each side of the culvert opening, and to a height of one culvert diameter above the top of the culvert. Rock may not restrict the flow of water into culvert inlets or catch basins. No placement by end dumping or dropping of rock is allowed.

5-27 ARMORING FOR STREAM CROSSING CULVERTS

At STREAM culverts (indicated in the REMARKS of the MATERIALS LIST), Purchaser shall place rip rap in conjunction with construction of the embankment. Rock must be placed on shoulders, slopes, and around culvert inlets and outlets as designated on the MATERIALS LIST and CULVERT AND DRAINAGE SPECIFICATIONS or as directed by the Contract Administrator. Rock may not restrict the flow of water into culvert inlets or catch basins. Rock must be set in place by machine. Placement must be with a zero-drop-height only. No placement by end dumping or dropping of rock is allowed. Rip rap must meet the specifications in Clause 6-50 LIGHT LOOSE RIP RAP and 6-50 HEAVY LOOSE RIP RAP

SECTION 6 – ROCK AND SURFACING

6-2 ROCK SOURCE ON STATE LAND

Rock used in accordance with the quantities on the TYPICAL SECTION and MATERIALS LIST may be obtained from the following source(s) on state land at no charge to the Purchaser. Purchaser shall obtain written approval from the Contract Administrator for the use of material from any other source. If other operators are using, or desire to use the rock source(s), a joint operating plan must be developed. All parties shall follow this plan.

<u>Source</u>	<u>Location</u>	<u>Rock Type</u>
HK-1801 Hard Rock Pit (Proposed)	STA 5+00 HK-18	RIPRAP, 3-INCH-MINUS BALLAST, AND SHOT ROCK.
HK-27 Hard Rock Pit	STA 144+00 HK-ML	RIPRAP, 3-INCH-MINUS BALLAST, AND SHOT ROCK.

6-5 ROCK FROM COMMERCIAL SOURCE

Rock used in accordance with the quantities on the TYPICAL SECTION and MATERIALS LIST may be obtained from any commercial source at the Purchaser's expense. Rock sources are subject to written approval by the Contract Administrator before their use.

6-11 ROCK SOURCE DEVELOPMENT PLAN BY PURCHASER

Purchaser shall conduct rock source development and use at the sources listed in clause 6-2 ROCK SOURCE ON STATE LAND, in accordance with a written ROCK SOURCE DEVELOPMENT PLAN to be prepared by the Purchaser. The plan is subject to written approval by the Contract Administrator before left in the condition specified in the ROCK SOURCE DEVELOPMENT PLAN, and approved in writing by the Contract Administrator.

Rock source development plans prepared by the Purchaser must show the following information:

- Rock source location.
- Rock source overview showing access roads, development areas, stockpile locations, waste areas, and floor drainage.
- Rock source profiles showing development areas, bench locations including widths, and wall faces including heights.

6-12 ROCK SOURCE SPECIFICATIONS

Rock sources must be in accordance with the following specifications:

- Pit walls may not be undermined or over steepened. The maximum slope of the walls must be consistent with recognized engineering standards for the type of material being excavated in accordance with the following table:

Material	Maximum Slope Ratio (Horiz. :Vert.)	Maximum Slope Percent
Sand	2:1	50
Gravel	1.5:1	67
Common Earth	1:1	100
Fractured Rock	0.5:1	200
Solid Rock	0:1	vertical

- Pit walls must be maintained in a condition to minimize the possibility of the walls sliding or failing.
- The width of pit benches must be a minimum of 1.5 times the maximum length of the largest machine used.
- The surface of pit floors and benches must be uniform and free-draining at a minimum 2% outslope gradient.
- All operations must be carried out in compliance with all regulations of the Regulations and Standards Applicable to Metal and Nonmetal Mining and Milling Operations (30 CFR) U.S. Department of Labor, Mine Safety and Health Administration and Safety Standards for Construction Work (296-155 WAC), Washington Department of Labor and Industries.
- All vehicle access to the top of the pit faces must be blocked.

6-14 DRILL AND SHOOT

Rock drilling and shooting must meet the following specifications:

- Oversize material remaining in the rock source at the conclusion of the timber sale may not exceed 5% of the total volume mined in that source.
- Oversize material is defined as rock fragments too large to be converted by the Purchaser to a size that will meet specifications used for the roads in this sale.
- Oversized rock that exceeds the maximum allowable amount must be left in a stable condition in full contact with the ground so that it does not present a fall hazard.
- Purchaser shall notify the Contract Administrator 7-21 working days before blasting operations.
- All operations must be carried out in compliance with the Regulations and Standards Applicable to Metal and Nonmetal Mining and Milling Operations (30 CFR) U.S. Department of Labor, Mine Safety and Health Administration and the Safety Standards for Construction Work (296-155 WAC), Washington Department of Labor and Industries.
- Purchaser shall block access roads and trails before blasting operations.

6-21 IN-PLACE PROCESSING

Purchaser may use in-place processing, such as a grid roller or other method, if suitable crushing can be demonstrated to meet the surfacing size-specified in Clause 6-38 4-INCH IN-PLACE ROCK. Purchaser shall remove any existing organic debris before the start of in-place crushing operations. The use of in-place processing methods is subject to written approval by the Contract Administrator.

6-22 FRACTURE REQUIREMENT FOR ROCK

A minimum of 50% by visual inspection of coarse aggregate must have at least one fractured face. Coarse aggregate is the material greater than 1/4-inch in size.

6-23 ROCK GRADATION TYPES

Purchaser shall provide rock in accordance with the types and amounts listed in the TYPICAL SECTION and MATERIALS LIST. Rock must meet the following specifications for gradation and uniform quality when placed in hauling vehicles or during manufacture and placement into a stockpile. The exact point of evaluation for conformance to specifications will be determined by the Contract Administrator.

6-34 3-INCH MINUS BALLAST ROCK

Ballast rock must be 100% equal to, or smaller than, 3 inches in at least one dimension.

Rock may contain no more than 5 percent organic debris, dirt, and trash. All percentages are by weight.

6-38 4-INCH IN-PLACE ROCK

4-inch in-place rock must have a minimum of 90 percent of the top 4 inches of the running surface pass a 4-inch square opening.

In-place rock may not contain organic debris and trash. No more than 50 percent of rock may be larger than 8 inches in any dimension and no rock may be larger than 12 inches in any dimension.

6-50 LIGHT LOOSE RIP RAP

Light loose rip rap must consist of angular, hard, sound, and durable stone. It must be free from segregation, seams, cracks, and other defects tending to destroy its resistance to weather. Light loose rip rap must be free of rock fines, soil, organic debris or other extraneous material, and must meet the following requirements:

<u>Quantity</u>	<u>Approximate Size Range</u>
20% to 90%	500 lbs. to 1 ton (18" - 28")
15% to 80%	50 lbs. to 500 lbs. (8" - 18")
10% to 20%	3 inch to 50 lbs. (3" - 8")

6-51 HEAVY LOOSE RIP RAP

Heavy loose rip rap must consist of angular, hard, sound, and durable stone. It must be free from segregation, seams, cracks, and other defects tending to destroy its resistance to weather. Heavy loose rip rap must be free of rock fines, soil, organic debris or other extraneous material, and must meet the following requirements:

<u>Quantity</u>	<u>Size Range</u>
30% to 90%	1 ton to 2 ton (28" - 36")
30% to 70%	500 lbs. to 1 ton (18" - 28")
20% to 50%	50 lbs. to 500 lbs. (8" - 18")
10% to 20%	3 inch to 50 lbs. (3" - 8")

6-55 ROCK APPLICATION MEASURED BY COMPACTED DEPTH

Measurement of specified rock depths, are defined as the compacted depth(s) using the compaction methods required in this road plan. Estimated quantities specified in the TYPICAL SECTION are loose yards. Purchaser shall apply adequate amounts of rock to meet the specified rock depths. Specified rock depths are minimum requirements, and are not subject to reduction.

6-70 APPROVAL BEFORE ROCK APPLICATION

Purchaser shall obtain written approval from the Contract Administrator for culvert installation, ditch construction, ditch reconstruction, headwall construction, and headwall reconstruction before rock application.

6-71 ROCK APPLICATION

Purchaser shall apply rock in accordance with the specifications and quantities shown on the TYPICAL SECTION. Rock must be spread, shaped, and compacted full width concurrent with rock hauling operations. The Contract Administrator will direct locations for rock that is to be applied as spot patching. Road surfaces must be compacted in accordance with the TYPICAL SECTION by routing equipment over the entire width.

6-73 ROCK FOR WIDENED PORTIONS

Purchaser shall apply rock to turnarounds, turnouts, and areas with curve widening to the same depth and specifications as the traveled way.

SECTION 7 – STRUCTURES

7-6 STREAM CROSSING INSTALLATION

Purchaser shall install stream crossing structures in accordance with the manufacturer's requirements, and the bridge installation details.

7-18 INSTALLATION PRODUCTION SCHEDULE

Purchaser shall provide the Contract Administrator or their designee, with a production schedule showing projected completion dates for the following items before starting construction of the structure(s). Production schedule must include:

- excavation
- placement of sills/abutments/footings/structure
- backfill compaction, rock application and compaction

7-19 INSTALLATION STAGE ACCEPTANCE

Purchaser shall ensure that all materials and procedures used during construction comply with the design. Purchaser shall obtain written approval from the Contract Administrator or their designee, after verification by the Region Engineer or designee for each stage of construction, listed in Clause 7-18 INSTALLATION PRODUCTION SCHEDULE, before starting construction on the next stage. Purchaser shall notify the Contract Administrator in writing when each construction stage is complete.

7-20 INSTALLATION FINAL ACCEPTANCE

Purchaser shall notify the Contract Administrator in writing when each structure is complete.

7-45 PURCHASER SUPPLIED BRIDGE

Purchaser shall provide, and construct each bridge listed below. Refer to BRIDGE INSTALLATION DETAIL.

Road	Station	Length (ft.)	Vert. Clear ² (ft.)	W.B.S.R. ¹ (ft.)	Type	Running Surface
HK-15	45+40	50	5	14	LOG STRINGER ³	3-INCH-MINUS BALLAST
HK-15	59+00	50	7.5	14	LOG STRINGER ³	3-INCH-MINUS BALLAST

¹W.B.S.R. = Width between shear rails.

²Vertical clearance shall be measured from 100 year flood level.

³Construct in accordance with the LOG STRINGER BRIDGE DETAIL

7-47 PURCHASER SUPPLIED ABUTMENTS

PURCHASER shall provide abutment designs. Bridge abutments must be designed by an engineer licensed in the state or province of manufacture. The abutment design includes, but is not limited to endwalls, precast concrete spread footing, and steel tower assembly.

7-53 BRIDGE INSTALLATION

Purchaser shall install bridges ensuring there is a full width, continuous deck with no gaps that allow water and sediment to drain from the bridge to the stream.

SECTION 8 – EROSION CONTROL

8-2 PROTECTION FOR EXPOSED SOIL

Purchaser shall provide and evenly spread a 4-inch layer of straw to all exposed soils at culvert installations. Soils must be covered before the first anticipated storm event. Soils may not sit exposed during any rain event.

8-5 CHECK DAM

On the following road(s), Purchaser shall construct rock check dams every 4 vertical feet in the ditch. Check dams must be built with 3-inch minus ballast rock to a depth of 8 inches and a length of 4 feet.

<u>Road</u>	<u>Stations</u>	<u>Minimum Count</u>
HK-15	1+20 TO 2+20	2
HK-15	41+80 TO 42+50	2
HK-15	52+00 TO 55+80	10
HK-15	58+70 TO 60+00	8
HK-15	61+80 TO 64+20	6

8-15 REVEGETATION

Purchaser shall spread seed and fertilizer on all exposed soils within the grubbing limits resulting from road work activities. Cover all exposed soils using manual dispersal of grass seed and fertilizer. Other methods of covering must be approved in writing by the Contract Administrator.

8-16 REVEGETATION SUPPLY

The Purchaser shall provide the grass seed and fertilizer as directed in clauses 8-25 GRASS SEED and 8-27 FERTILIZER.

8-17 REVEGETATION TIMING

Purchaser shall revegetate during the first available opportunity after road work is completed. Soils may not be allowed to sit exposed for longer than one month without receiving revegetation treatment unless otherwise approved in writing by the Contract Administrator.

8-18 PROTECTION FOR SEED

Purchaser shall provide a protective cover for seed if revegetation occurs between July 1 and March 31. The protective cover may consist of dispersed straw, jute matting, or clear plastic sheets. The protective cover requirement may be waived in writing by the Contract Administrator if Purchaser is able to demonstrate a revegetation plan that will result in the establishment of a uniform dense crop (at least 50% coverage) of 3-inch tall grass by October 31

8-19 ASSURANCE FOR SEEDED AREA

Purchaser shall ensure the growth of a uniform and dense crop (at least 50% coverage) of 3-inch tall grass. Purchaser shall reapply the grass seed and fertilizer in areas that have failed to germinate or have been damaged through any cause. Restore eroded or disturbed areas, clean up and properly dispose of eroded materials, and reapply the seed and fertilizer at no addition cost to the state.

8-25 GRASS SEED

Purchaser shall evenly spread the seed mixture listed below on all exposed soil inside the grubbing limits at a rate of 50 pounds per acre of exposed soil. Grass seed must meet the following specifications:

1. Weed seed may not exceed 0.5% by weight.
2. All seed species must have a minimum 90% germination rate, unless otherwise specified.
3. Seed must be certified.
4. Seed must be furnished in standard containers showing the following information:
 - a. Common name of seed
 - b. Net weight
 - c. Percent of purity
 - d. Percentage of germination
 - e. Percentage of weed seed and inert material
5. Seed must conform to the following mixture unless a comparable mix is approved in writing by the Contract Administrator.

<u>Kind and Variety of Seed in Mixture</u>	<u>% by Weight</u>
Creeping Red Fescue	50
Elf Perennial Rye Grass	25
Highland Colonial Bentgrass	15
White Clover	10
Inert and Other Crop	0.5

Do not use seed sources that have the label "other seeds"- these can contain invasive species.

Mulch with straw to achieve no more than 70% cover, evenly distributed, at a rate of 1.5 to 2 tons per acre.

8-27 FERTILIZER

Purchaser shall evenly spread the fertilizer listed below on all exposed soil inside the grubbing limits at a rate of 200 pounds per acre of exposed soil. Fertilizer must meet the following specifications:

<u>Chemical Component</u>	<u>% by Weight</u>
Nitrogen	16
Phosphorous	16
Potassium	16
Sulphur	3
Inerts	49

SECTION 9 – POST-HAUL ROAD WORK

9-3 CULVERT MATERIAL REMOVED FROM STATE LAND

Culverts removed from roads become the property of the Purchaser and must be removed from state land.

9-5 POST-HAUL MAINTENANCE

Purchaser shall perform post-haul maintenance in accordance with the FOREST ACCESS ROAD MAINTENANCE SPECIFICATIONS.

9-10 LANDING DRAINAGE

Purchaser shall provide for drainage of the landing surface.

9-21 ROAD ABANDONMENT

Purchaser shall abandon the following before the termination of this contract:

<u>Road</u>	<u>Stations</u>	<u>Type</u>
HK-1509	0+00 to 11+10	ABANDONMENT
HK-26	0+00 TO 13+80	ABANDONMENT
HK-2601	0+00 TO 5+50	ABANDONMENT
HK-27	0+00 TO 3+00	ABANDONMENT
HK-29	0+00 TO 9+20	ABANDONMENT
HK-30	0+00 to 2+60	ABANDONMENT

9-22 ABANDONMENT

- Remove all ditch relief culverts. The resulting slopes must be 1:1 or flatter. Place and compact the removed fill material in a location that will not erode into any Type 1 through 5 waters or wetlands.
- Remove all culverts in natural drainages. The resulting slopes must be 1.5:1 or flatter. Strive to match the existing native stream bank gradient. The natural streambed width must be re-established. Place and compact the removed fill material in a location that will not erode into any Type 1 through 5 waters or wetlands.
- Transport all removed culverts off site. All removed culverts are the property of the Purchaser.
- Construct non-drivable waterbars at natural drainage points and at a spacing that will produce a vertical drop of no more than 20 feet between waterbars and with a maximum horizontal spacing of 400 feet.
- Skew waterbars at least 30 degrees from perpendicular to the road centerline on roads in excess of 3 percent grade.
- Key waterbars into the cut-slope to intercept the ditch. Waterbars must be outsloped to provide positive drainage. Outlets must be on stable locations.
- Inslope or outslope the road as appropriate.
- Remove bridges and other structures.
- Pull back unstable fill that has potential of failing and entering any Type 1 through 5 waters or wetlands. Place and compact removed material in a stable location.
- Remove berms except as designed.
- Block the road by constructing an aggressive barrier of dense interlocked large woody debris (logs, stumps, root wads, etc.) so that four wheel highway vehicles cannot pass the point of abandonment. Typical barrier dimensions are 10 feet high by 20 feet deep, spanning the entire road prism from top of cutslope to toe of fillslope. Long term effectiveness is the primary objective. If necessary construct a vehicular turn-around near the point of abandonment.
- Apply grass seed to all exposed soils resulting from the abandonment work and in accordance with Section 8 EROSION CONTROL.

SECTION 10 MATERIALS

10-3 GEOTEXTILE FOR STABILIZATION

Geotextiles must meet the following minimum requirements for strength and property qualities, and must be designed by the manufacturer to be used for stabilization or reinforcement, and filtration. Material must be free of defects, cuts, and tears.

	<u>ASTM Test</u>	<u>Requirements</u>
Type	--	Woven
Apparent opening size	D 4751	No. 40 max
Water permittivity	D 4491	0.10 sec ⁻¹
Grab tensile strength	D 4632	315 lb
Grab tensile elongation	D 4632	50%
Puncture strength	D 6241	620 lb
Tear strength	D 4533	112 lb
Ultraviolet stability	D 4355	50% retained after 500 hours of exposure

10-15 CORRUGATED STEEL CULVERT

Metallic coated steel culverts must meet AASHTO M-36 (ASTM A-760) specifications. Culverts must be galvanized (zinc coated meeting AASHTO M-218).

10-16 CORRUGATED ALUMINUM CULVERT

Aluminum culverts must meet AASHTO M-196 (ASTM A-745) specifications.

10-17 CORRUGATED PLASTIC CULVERT

Polyethylene culverts must meet AASHTO M-294 specifications, or ASTM F-2648 specifications for recycled polyethylene. Culverts must be Type S – double walled with a corrugated exterior and smooth interior.

10-21 METAL BAND

Metal coupling and end bands must meet the AASHTO specification designated for the culvert and must have matching corrugations. Culverts 24 inches and smaller must have bands with a minimum width of 12 inches. Culverts over 24 inches must have bands with a minimum width of 24 inches.

10-22 PLASTIC BAND

Plastic coupling and end bands must meet the AASHTO specification designated for the culvert. Only fittings supplied or recommended by the culvert manufacturer may be used.

10-24 GAUGE AND CORRUGATION

Unless otherwise stated, metal culverts must conform to the following specifications for gage and corrugation as a function of diameter.

<u>Diameter</u>	<u>Gage</u>	<u>Corrugation</u>
18"	16 (0.064")	2 ² / ₃ " X 1/2"
24" to 48"	14 (0.079")	2 ² / ₃ " X 1/2"
54" to 96"	14 (0.079")	3" X 1"

DRAFT

ROAD #		HK-ML	PT-14	HK-15	HK-15
REQUIRED / OPTIONAL		REQUIRED	REQUIRED	REQUIRED	REQUIRED
CONSTRUCT / RECONSTRUCT		MAINTAIN	MAINTAIN	CONSTRUCT	CONSTRUCT
TOLERANCE CLASS (A/B/C)		C	C	C	C
STATION / MP TO		0+00	0+00	0+00	15+90
STATION / MP		158+30	27+20	15+90	26+40
ROAD WIDTH	R	12	12	12	12
CROWN (INCHES @ C/L)		3	3	3	3
DITCH WIDTH	W	2	2	2	2
DITCH DEPTH	D	1	1	1	1
TURNOUT LENGTH	L	50	50	50	50
TURNOUT WIDTH	T	10	10	10	10
TURNOUT TAPER	P	25	25	25	25
GRUBBING	G1	-	-	5	5
	G2	-	-	5	5
CLEARING	C1	-	-	10	10
	C2	-	-	10	10
ROCK FILLSLOPE	K:1	-	-	1 ½	1 ½
❖ BALLAST DEPTH	B1	-	-	18	12
CUBIC YARDS / STATION		-	-	114	72
➤ TOTAL CY BALLAST		-	-	1820	760
❖ SURFACING DEPTH	B2				
CUBIC YARDS / STATION					
➤ TOTAL CY SURFACING					
➤ TOTAL CUBIC YARDS		-	-	1820	760
SUBGRADE WIDTH	S	-	-	16.5	16.5
BRUSHCUT (Y/N)		Y	Y	N/A	N/A
BLADE, SHAPE, & DITCH (Y/N)		-	-	N/A	N/A

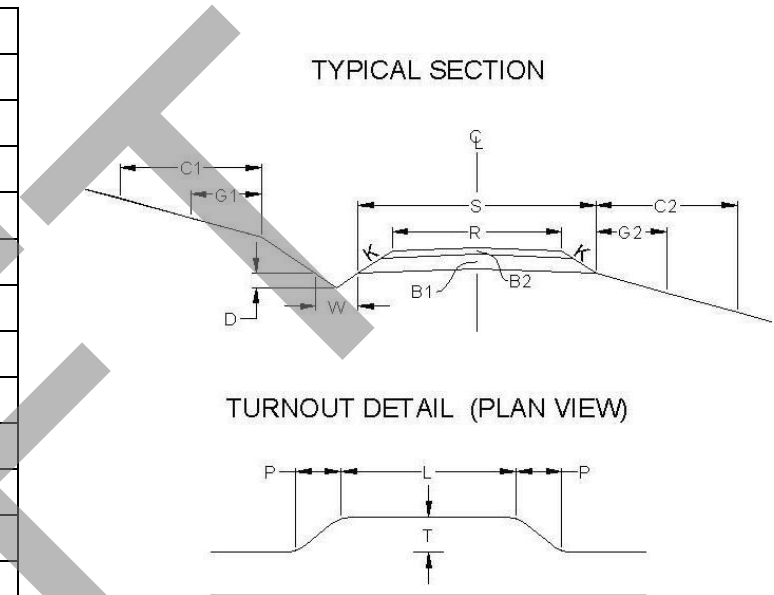

SYMBOL NOTES

- ❖ Specified Rock Depth is FINISHED COMPACTED DEPTH in inches.
- Specified Rock Quantity is LOOSE MEASURE (Truck Cubic Yards) needed to accomplish specified FINISHED COMPACTED DEPTH. Rock quantities include volume for turnouts, curve widening and landings.
- * Proposed road is located on an abandoned grade

Rock Totals Summary

Type	Quantity (Cubic Yards)
Ballast	9980
Rip Rap	346

ROAD #		HK-15	HK-15	HK-15	HK-15	HK-15	HK-15	HK-1509	HK-1509	HK-18
REQUIRED / OPTIONAL		REQUIRED	REQUIRED	REQUIRED	OPTIONAL	OPTIONAL	OPTIONAL	OPTIONAL	OPTIONAL	OPTIONAL
CONSTRUCT / RECONSTRUCT		CONSTRUCT	CONSTRUCT	CONSTRUCT	CONSTRUCT	CONSTRUCT	CONSTRUCT	CONSTRUCT	CONSTRUCT	CONSTRUCT
TOLERANCE CLASS (A/B/C)		C	C	C	C	C	C	C	C	C
STATION / MP TO		26+40	45+40	45+90	47+10	59+00	59+50	0+00	6+50	0+00
STATION / MP		45+40	45+90	47+10	59+00	59+50	66+40	6+50	11+10	6+80
ROAD WIDTH	R	12	14	12	12	14	12	12	12	12
CROWN (INCHES @ C/L)		3		3	3		3	3	3	3
DITCH WIDTH	W	2		2	2		2	1	1	2
DITCH DEPTH	D	1		1	1		1	1	1	1
TURNOUT LENGTH	L	50		50	50		50	25	25	50
TURNOUT WIDTH	T	10		10	10		10	10	10	10
TURNOUT TAPER	P	25		25	25		25	25	25	25
GRUBBING	G1	5		5	5		5	5	5	-
	G2	5		5	5		5	5	5	-
CLEARING	C1	10		10	10		10	10	10	-
	C2	10		10	10		10	10	10	-
ROCK FILLSLOPE	K:1	1 ½		1 ½	1 ½		1 ½	1 ½	1 ½	-
❖ BALLAST DEPTH	B1	18	6	12	18	6	18	12	18	-
CUBIC YARDS / STATION		114	34	72	114	34	114	72	114	-
➤ TOTAL CY BALLAST		2170	20	90	1360	20	790	470	530	-
❖ SURFACING DEPTH	B2									
CUBIC YARDS / STATION										
➤ TOTAL CY SURFACING										
➤ TOTAL CUBIC YARDS		2170	20	90	1360	20	790	470	530	-
SUBGRADE WIDTH	S	16.5	N/A	15.0	16.5	N/A	16.5	15.0	16.5	-
BRUSHCUT (Y/N)		N/A	N/A	N/A	N/A	N/A	N/A	N/A	N/A	Y
BLADE, SHAPE, & DITCH (Y/N)		N/A	N/A	N/A	N/A	N/A	N/A	N/A	N/A	-

50' FOOT SPAN, GRAVEL DECK,
LOG STRINGER BRIDGE

50' FOOT SPAN, GRAVEL DECK,
LOG STRINGER BRIDGE

ROAD #		HK-18	HK-26*	HK-2601*	HK-2601	HK-27	HK-29*	HK-29	HK-30	
REQUIRED / OPTIONAL		OPTIONAL	OPTIONAL	OPTIONAL	OPTIONAL	OPTIONAL	OPTIONAL	OPTIONAL	OPTIONAL	
CONSTRUCT / RECONSTRUCT		CONSTRUCT	CONSTRUCT	CONSTRUCT	CONSTRUCT	CONSTRUCT	CONSTRUCT	CONSTRUCT	CONSTRUCT	
TOLERANCE CLASS (A/B/C)		C	C	C	C	C	C	C	C	
STATION / MP TO		6+80	0+00	0+00	3+60	0+00	0+00	3+20	0+00	
STATION / MP		10+20	13+80	3+60	5+50	3+00	3+20	9+20	2+60	
ROAD WIDTH	R	12	12	12	12	12	12	12	12	
CROWN (INCHES @ C/L)		3	3	3	3	3	3	3	3	
DITCH WIDTH	W	2	2	2	2	2	2	2	2	
DITCH DEPTH	D	1	1	1	1	1	1	1	1	
TURNOUT LENGTH	L	50	50	50	50	50	50	50	50	
TURNOUT WIDTH	T	10	10	10	10	10	10	10	10	
TURNOUT TAPER	P	25	25	25	25	25	25	25	25	
GRUBBING	G1	5	5	5	5	5	5	5	5	
	G2	5	5	5	5	5	5	5	5	
CLEARING	C1	10	10	10	10	10	10	10	10	
	C2	10	10	10	10	10	10	10	10	
ROCK FILLSLOPE	K:1	1 ½	1 ½	1 ½	1 ½	1 ½	1 ½	1 ½	1 ½	
❖ BALLAST DEPTH	B1	12	6	6	12	12	6	12	12	
CUBIC YARDS / STATION		72	34	34	72	72	34	72	72	
➤ TOTAL CY BALLAST		250	470	130	140	220	110	440	190	
❖ SURFACING DEPTH	B2									
CUBIC YARDS / STATION										
➤ TOTAL CY SURFACING										
➤ TOTAL CUBIC YARDS		250	470	130	140	220	110	440	190	
SUBGRADE WIDTH	S	15.0	13.5	13.5	15.0	15.0	13.5	15.0	15.0	
BRUSHCUT (Y/N)		N/A	N/A	N/A	N/A	N/A	N/A	N/A	N/A	
BLADE, SHAPE, & DITCH (Y/N)		N/A	N/A	N/A	N/A	N/A	N/A	N/A	N/A	

MATERIALS LIST

LOCATION		CULVERT			DWNSPT		RIPRAP			FILL TYPE	TOLERANCE	REMARKS											
ROAD #	STATION	DIAMETER	LENGTH	TYPE	LENGTH	TYPE	INLET	OUTLET	TYPE														
<p>Note: Galvanized metal culverts shall conform to the following specifications for gage and corrugation as a function of the diameter:</p> <table style="width: 100%; border-collapse: collapse;"> <thead> <tr> <th style="text-align: center;"><u>Diameter</u></th> <th style="text-align: center;"><u>Gage</u></th> <th style="text-align: center;"><u>Corrugation</u></th> </tr> </thead> <tbody> <tr> <td style="text-align: center;">18"</td> <td style="text-align: center;">16</td> <td style="text-align: center;">2 2/3" x 1/2"</td> </tr> <tr> <td style="text-align: center;">24" – 48"</td> <td style="text-align: center;">14</td> <td style="text-align: center;">2 2/3" x 1/2"</td> </tr> <tr> <td style="text-align: center;">54" – 96"</td> <td style="text-align: center;">14</td> <td style="text-align: center;">3" x 1"</td> </tr> </tbody> </table>												<u>Diameter</u>	<u>Gage</u>	<u>Corrugation</u>	18"	16	2 2/3" x 1/2"	24" – 48"	14	2 2/3" x 1/2"	54" – 96"	14	3" x 1"
<u>Diameter</u>	<u>Gage</u>	<u>Corrugation</u>																					
18"	16	2 2/3" x 1/2"																					
24" – 48"	14	2 2/3" x 1/2"																					
54" – 96"	14	3" x 1"																					
HK-15	1+20	-	-	-	-	-	-	-	-	-	-	Start checkdams (2). See clause 8-5 CHECK DAM											
	2+20	24	32	XX	-	-	3	5	L/H	NT	C	End checkdams											
	5+50	18	32	XX	-	-	2	3	L	NT	C												
	6+20	24	32	XX	-	-	2	3	L/H	NT	C												
	8+90	24	40	XX	-	-	3	5	L/H	NT	C												
	12+80	18	32	XX	-	-	2	3	L	NT	C												
	15+40	18	36	XX	-	-	2	3	L	NT	C												
	15+90	24	36	XX	-	-	3	5	L/H	NT	C	T5 STREAM											
	16+50	18	36	XX	-	-	3	5	L/H	NT	C												
	19+70	18	40	XX	-	-	3	5	L	NT	C												
	26+40	18	36	XX	-	-	2	3	L	NT	C												
	28+40	18	36	XX	-	-	2	3	L	NT	C												
	30+70	18	32	XX	-	-	2	3	L	NT	C												
	31+70	18	36	XX	-	-	2	3	L	NT	C												
	32+30	24	40	XX	-	-	3	5	L/H	NT	C	Above T5 stream											
	34+90	24	36	XX	-	-	3	5	L/H	NT	C												
	37+80	18	40	XX	-	-	2	3	L	NT	C												
	40+30	18	32	XX	-	-	2	3	L	NT	C												
	41+10	24	36	XX	-	-	3	5	L/H	NT	C	Intercept ditchline from orphaned grade											
	41+80	18	36	XX	-	-	2	3	L	NT	C	Start checkdams (2). See clause 8-5 CHECK DAM.											
	42+50	48	36	GM	-	-	8	12	L/H	NT	C	T4 STREAM. End checkdams											

GM – Galvanized Metal PS – Polyethylene Pipe Single Wall PD – Polyethylene Pipe Dual Wall AM – Aluminized Metal C – Concrete XX – PD or GM
H – Heavy Loose Riprap L – Light Loose Riprap SR – Shot Rock NT – Native (Bank Run) QS – Quarry Spalls

MATERIALS LIST

LOCATION		CULVERT			DWNST		RIPRAP			FILL TYPE	TOLERANCE	REMARKS											
ROAD #	STATION	DIAMETER	LENGTH	TYPE	LENGTH	TYPE	INLET	OUTLET	TYPE														
<p>Note: Galvanized metal culverts shall conform to the following specifications for gage and corrugation as a function of the diameter:</p> <table style="width: 100%; border-collapse: collapse;"> <thead> <tr> <th style="text-align: center;">Diameter</th> <th style="text-align: center;">Gage</th> <th style="text-align: center;">Corrugation</th> </tr> </thead> <tbody> <tr> <td style="text-align: center;">18"</td> <td style="text-align: center;">16</td> <td style="text-align: center;">2 2/3" x 1/2"</td> </tr> <tr> <td style="text-align: center;">24" – 48"</td> <td style="text-align: center;">14</td> <td style="text-align: center;">2 2/3" x 1/2"</td> </tr> <tr> <td style="text-align: center;">54" – 96"</td> <td style="text-align: center;">14</td> <td style="text-align: center;">3" x 1"</td> </tr> </tbody> </table>												Diameter	Gage	Corrugation	18"	16	2 2/3" x 1/2"	24" – 48"	14	2 2/3" x 1/2"	54" – 96"	14	3" x 1"
Diameter	Gage	Corrugation																					
18"	16	2 2/3" x 1/2"																					
24" – 48"	14	2 2/3" x 1/2"																					
54" – 96"	14	3" x 1"																					
HK-15 (cont'd)	44+90	18	40	XX	-	-	2	3	L	NT	C												
	45+40 to 45+90	50' FOOT SPAN, GRAVEL DECK, LOG STRINGER BRIDGE					10	-	L/H	-	A	T3 STREAM, see also Bridge Installation Details and clauses 3-6 and 3-11 for RFRS requirements.											
							-	10															
	46+60	18	36	XX	-	-	3	5	L	NT	C												
	49+00	30	40	XX	-	-	5	7	L/H	NT	C	Above type 4 stream											
	49+60	18	32	XX	-	-	2	3	L	NT	C												
	51+30	24	40	XX	-	-	3	5	L/H	NT	C												
	52+00	24	36	XX	-	-	3	5	L/H	NT	C	Start checkdams (10). See clause 8-5 CHECK DAM											
	53+20	30	40	XX	-	-	5	7	L/H	NT	C	T4 STREAM											
	55+40	42	52	GM	-	-	8	12	L/H	SR	C	T4 STREAM											
	55+80	-	-	-	-	-	-	-	-	-	-	End checkdams											
	57+70	24	40	XX	-	-	2	3	L	NT	C												
	58+70	-	-	-	-	-	-	-	-	-	-	Start checkdams (8). See clause 8-5 CHECK DAM											
	59+00 TO 59+50	50' FOOT SPAN, GRAVEL DECK, LOG STRINGER BRIDGE					10	-	L/H	-	A	T3 STREAM, see also Bridge Installation Details and clauses 3-6 and 3-11 for RFRS requirements.											
							-	20															
	60+00	-	-	-	-	-	-	-	-	-	-	End checkdams											
	61+80	24	36	XX	-	-	3	5	L/H	NT	C	Start checkdams (6). See clause 8-5 CHECK DAM											
	62+80	24	36	XX	-	-	3	5	L/H	NT	C	T5 STREAM											
	63+70	24	40	XX	-	-	3	5	L/H	NT	C												
	64+20	-	-	-	-	-	-	-	-	-	-	End checkdams											
	65+30	18	36	XX	-	-	2	3	L	NT	C												

GM – Galvanized Metal XX – PD or GM H – Heavy Loose Riprap L – Light Loose Riprap SR – Shot Rock NT – Native (Bank Run)

FOREST ACCESS ROAD MAINTENANCE SPECIFICATIONS

Cuts and Fills

- Maintain slope lines to a stable gradient compatible with the construction materials. Remove slides from ditches and the roadway. Repair fill-failures, in accordance with Clause 4-6 EMBANKMENT SLOPE RATIO, with selected material or material approved by the Contract Administrator. Remove overhanging material from the top of cut slopes.
- Waste material from slides or other sources shall be placed and compacted in stable locations identified in the road plan or approved by the Contract Administrator, so that sediment will not deliver to any streams or wetlands.
- Slide material and debris shall not be mixed into the road surface materials, unless approved by the Contract Administrator.

Surface

- Grade and shape the road surface, turnouts, and shoulders to the original shape on the TYPICAL SECTION SHEET. Inslope or outslope as directed to provide a smooth, rut-free traveled surface and maintain surface water runoff in an even, unconcentrated manner.
- Blading shall not undercut the backslope or cut into geotextile fabric on the road.
- If required by the Contract Administrator, water shall be applied as necessary to control dust and retain fine surface rock.
- Surface material shall not be bladed off the roadway. Replace surface material when lost or worn away, or as directed by the Contract Administrator.
- Remove shoulder berms, created by grading, to facilitate drainage, except as marked or directed by the Contract Administrator.
- For roads with geotextile fabric: spread surface aggregate to fill in soft spots and wheel ruts (barrel spread) to prevent damage to the geotextile fabric.

Drainage

- Prevent silt bearing road surface and ditch runoff from delivering sediment to any streams or wetlands.
- Maintain rolling dips and drivable waterbars as needed to keep them functioning as intended.
- Maintain headwalls to the road shoulder level with material that will resist erosion.
- Maintain energy dissipaters at culvert outlets with non-erodible material or rock.
- Keep ditches, culverts, and other drainage structures clear of obstructions and functioning as intended.
- Inspect and clean culverts at least monthly, with additional inspections during storms and periods of high runoff. This shall be done even during periods of inactivity.

Preventative Maintenance

- Perform preventative maintenance work to safeguard against storm damage, such as blading to ensure correct runoff, ditch and culvert cleaning, and waterbar maintenance.

Termination of Use or End of Season

- At the conclusion of logging operations, ensure all conditions of these specifications have been met.

Debris

- Remove fallen timber, limbs, and stumps from the slopes, roadway, ditchlines, and culvert inlets.

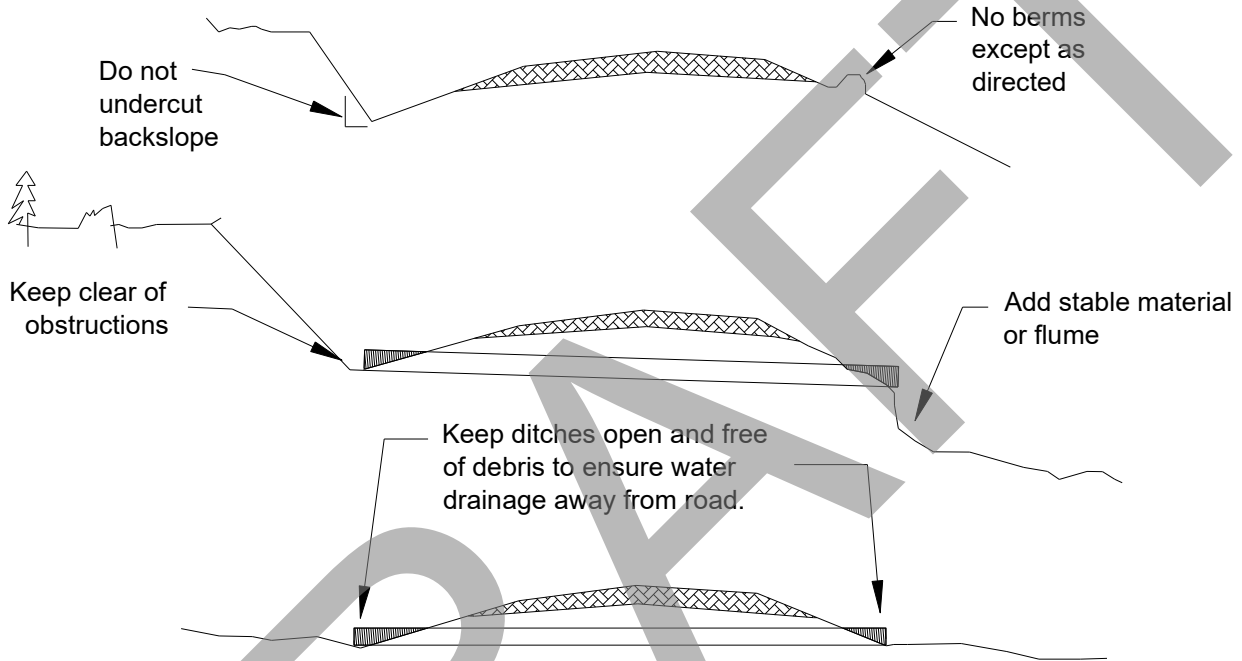

ROAD BRUSHING DETAILS

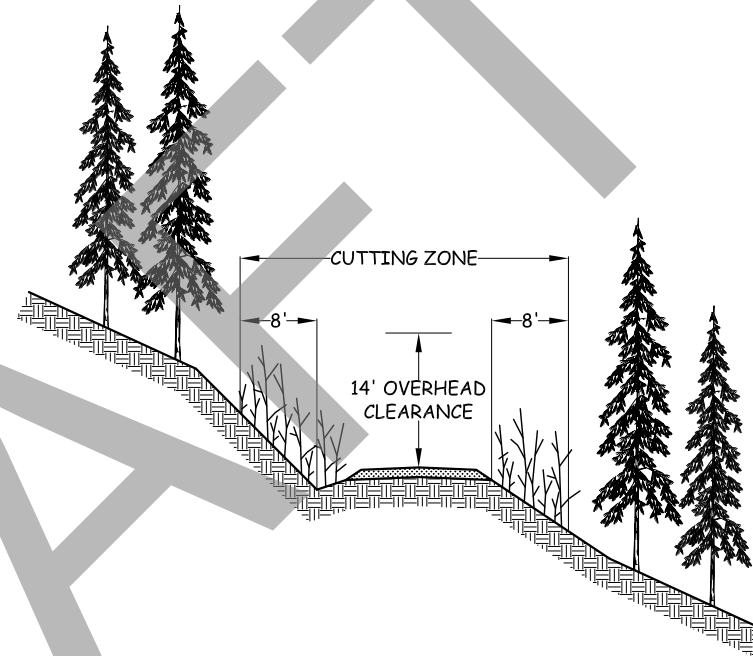

SPECIFICATIONS

BRUSH SHALL BE CUT ON THE ROAD SURFACE AND 8 ft. BACK FROM ROAD DITCH AND OUTSIDE EDGE OF RUNNING SURFACE.

ON THE INSIDE OF SWITCHBACKS AND TIGHT CURVES, BRUSH SHALL BE CUT BACK 16 ft. FOR VISIBILITY.

ON TRUCK TURNOUTS, BRUSH SHALL BE CUT 8 ft. BACK FROM OUTSIDE EDGE.

BRUSH SHALL BE CUT TO PROVIDE AN OVERHEAD CLEARANCE OF 14 ft. ABOVE THE ROAD RUNNING SURFACE.

BRUSH SHALL BE CUT TO WITHIN 6 in. OF THE GROUND.

SLASH SHALL BE REMOVED FROM CUT SLOPES ABOVE THE ROAD AND SCATTERED ON EMBANKMENT SLOPES.

DITCHES SHALL BE CLEARED OF WOODY DEBRIS.

CULVERT INLETS AND OUTLETS SHALL BE CLEANED A MINIMUM DISTANCE OF TWO PIPE DIAMETERS AWAY.

CONTRACT #	PROJECT	SHEET
30-104444	RIDGE ENDER	36 OF 42

CULVERT AND DRAINAGE SPECIFICATIONS

CULVERT INSTALLATION (TYPICAL)

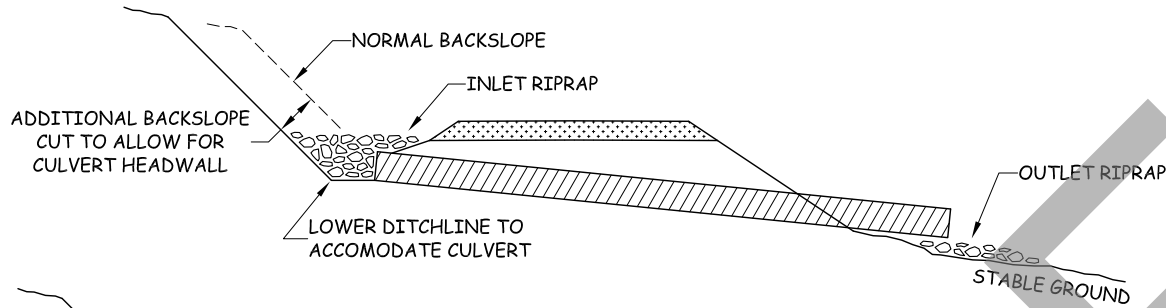

CULVERT HEADWALL - SECTION VIEW

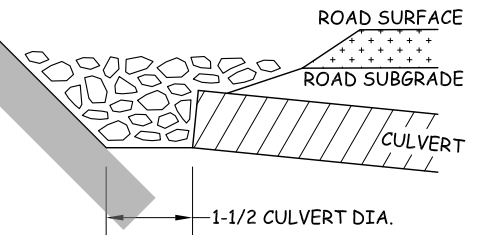

CULVERT INSTALLATION WITH DOWNSPOUT

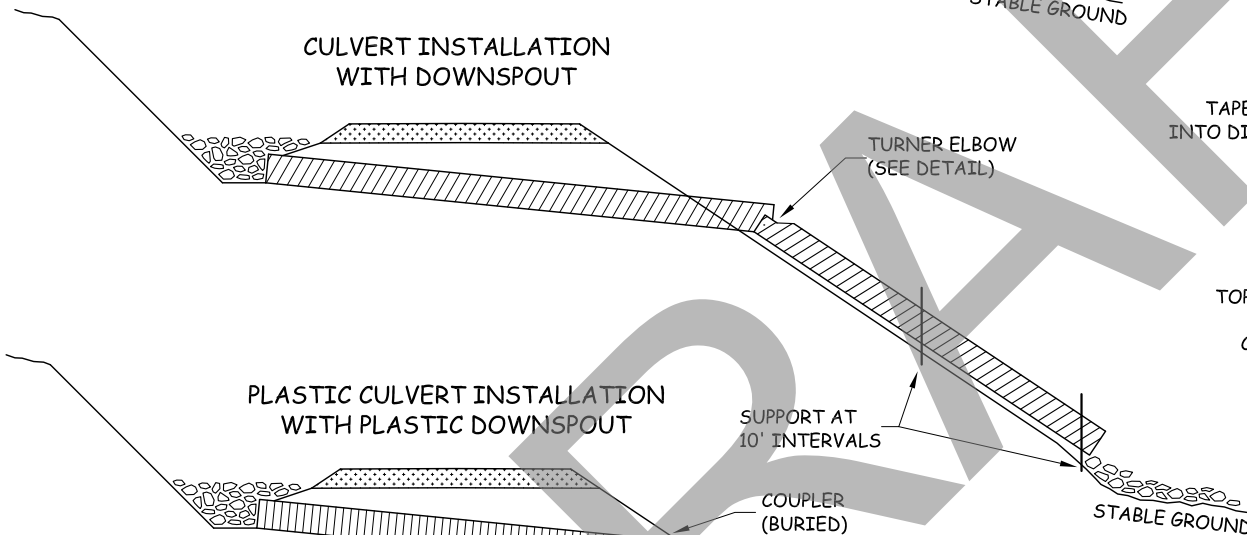

CULVERT HEADWALL - PLAN VIEW

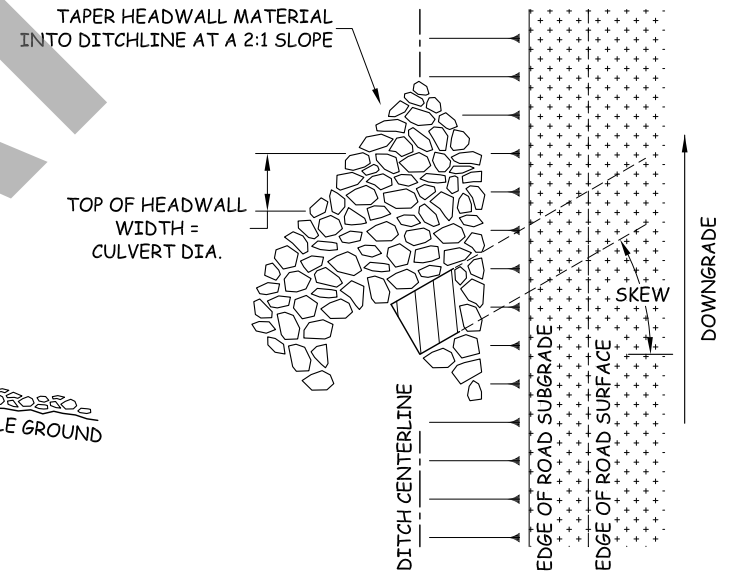

PLASTIC CULVERT INSTALLATION WITH PLASTIC DOWNSPOUT

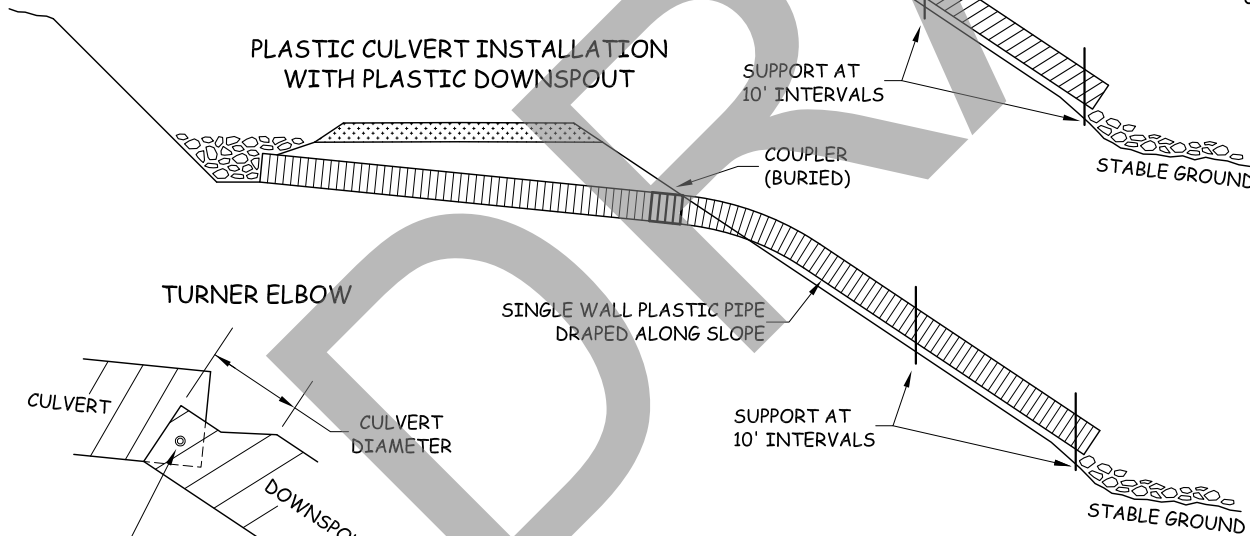

TURNER ELBOW

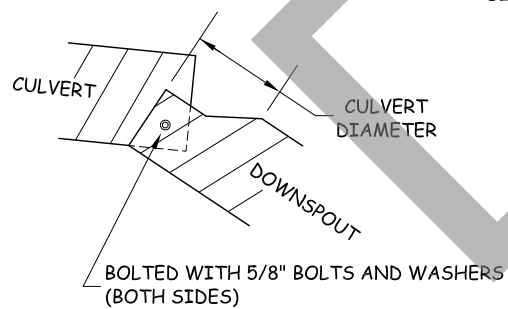

HEADWALL NOTE:

HEADWALL TO BE CONSTRUCTED OF IMPERVIOUS MATERIAL THAT WILL RESIST EROSION AND ARMORED WITH RIPRAP QUANTITY SPECIFIED IN ROAD PLAN.

CONTRACT #	PROJECT	SHEET
30-104444	RIDGE ENDER	37 OF 42

LOG STRINGER BRIDGE INSTALLATION DETAILS

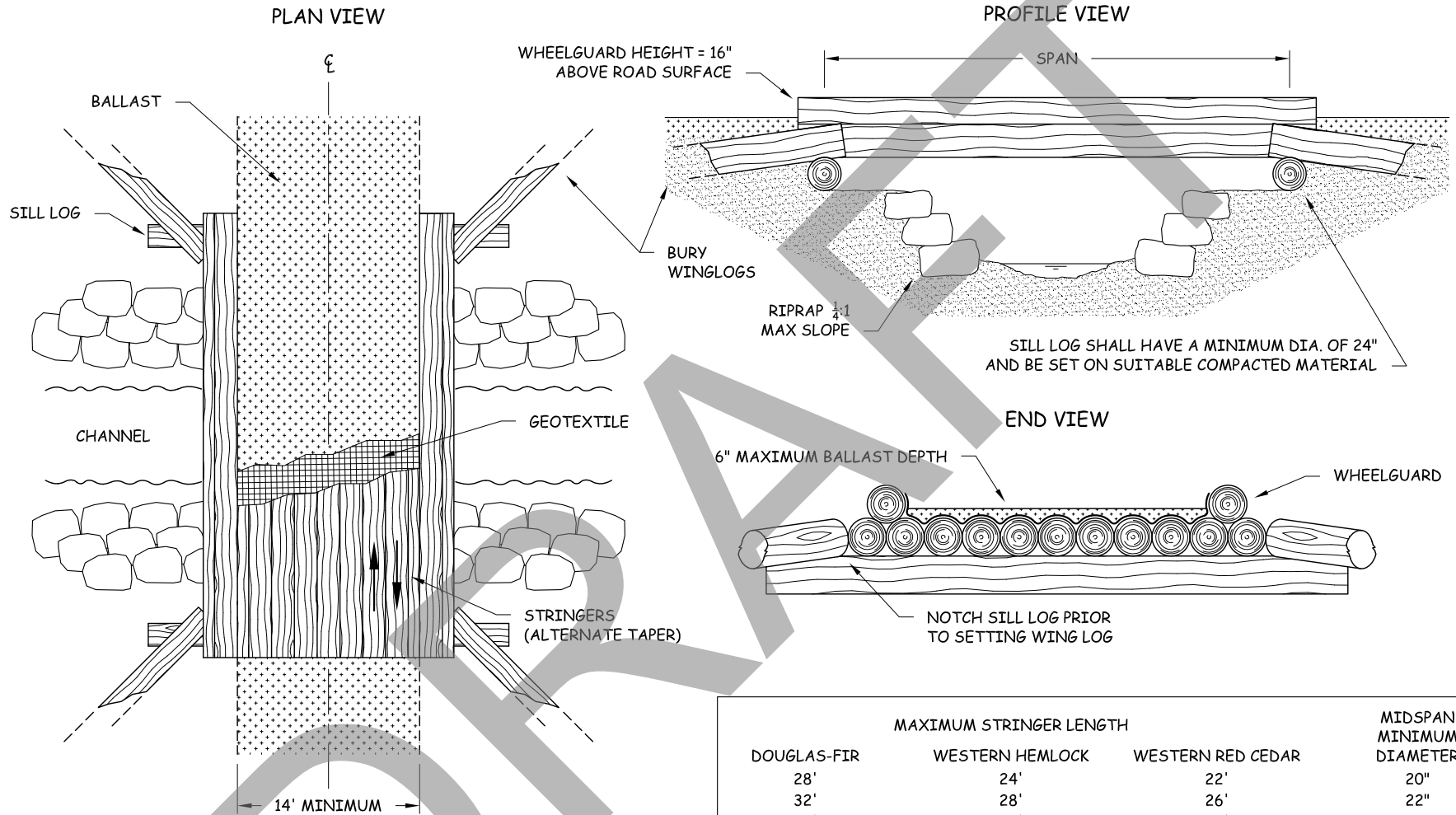

NOTES:

- ALL MATERIALS SHALL BE APPROVED BY THE CONTRACT ADMINISTRATOR.
- ANY DESIGN CHANGES SHALL BE APPROVED BY THE CONTRACT ADMINISTRATOR.
- STRINGERS AND WHEELGUARDS SHALL BE LASHED TOGETHER WITH 7/8" WIRE ROPE NEAR EACH END OF THE STRUCTURE.
- WING LOGS SHALL BE LASHED TO SILL LOG AND STRINGERS WITH 7/8" WIRE ROPE AT EACH END OF STRUCTURE.
- ALL BARK SHALL BE PEELED FROM LOGS PRIOR TO CONSTRUCTION.

DOUGLAS-FIR	MAXIMUM STRINGER LENGTH		MIDSPAN MINIMUM DIAMETER
	WESTERN HEMLOCK	WESTERN RED CEDAR	
28'	24'	22'	20"
32'	28'	26'	22"
36'	32'	28'	24"
38'	34'	32'	26"
42'	38'	34'	27"
46'	40'	38'	29"
48'	44'	40'	31"
52'	46'	42'	33"
56'	50'	46'	35"
60'	52'	48'	37"

DRAWINGS NOT TO SCALE

CONTRACT #	PROJECT	SHEET
30-104444	RIDGE ENDER	38 OF 42



WASHINGTON STATE
DEPT. OF NATURAL RESOURCES
NORTHWEST REGION

STA 45+40 HK-15 ROAD 50' LOG STRINGER BRIDGE

PLAN VIEW

BMK2 1143.9'

FPA NOTES

LANDOWNER: WASHINGTON STATE DEPARTMENT OF NATURAL RESOURCES

1. AVERAGE CBW = 18.1' BASED ON SIX MEASUREMENTS
2. 5.4% AVERAGE CHANNEL GRADIENT WITHIN SURVEYED REACH
3. NO CHANNEL REGRADE EXPECTED.
4. DOWNSTREAM SURVEY LIMITED FOR SAFETY DUE TO PRESENCE OF WATERFALL

SEE ALSO 'LOG STRINGER BRIDGE INSTALLATION DETAILS' FOR ADDITIONAL BRIDGE SPECIFICATIONS.

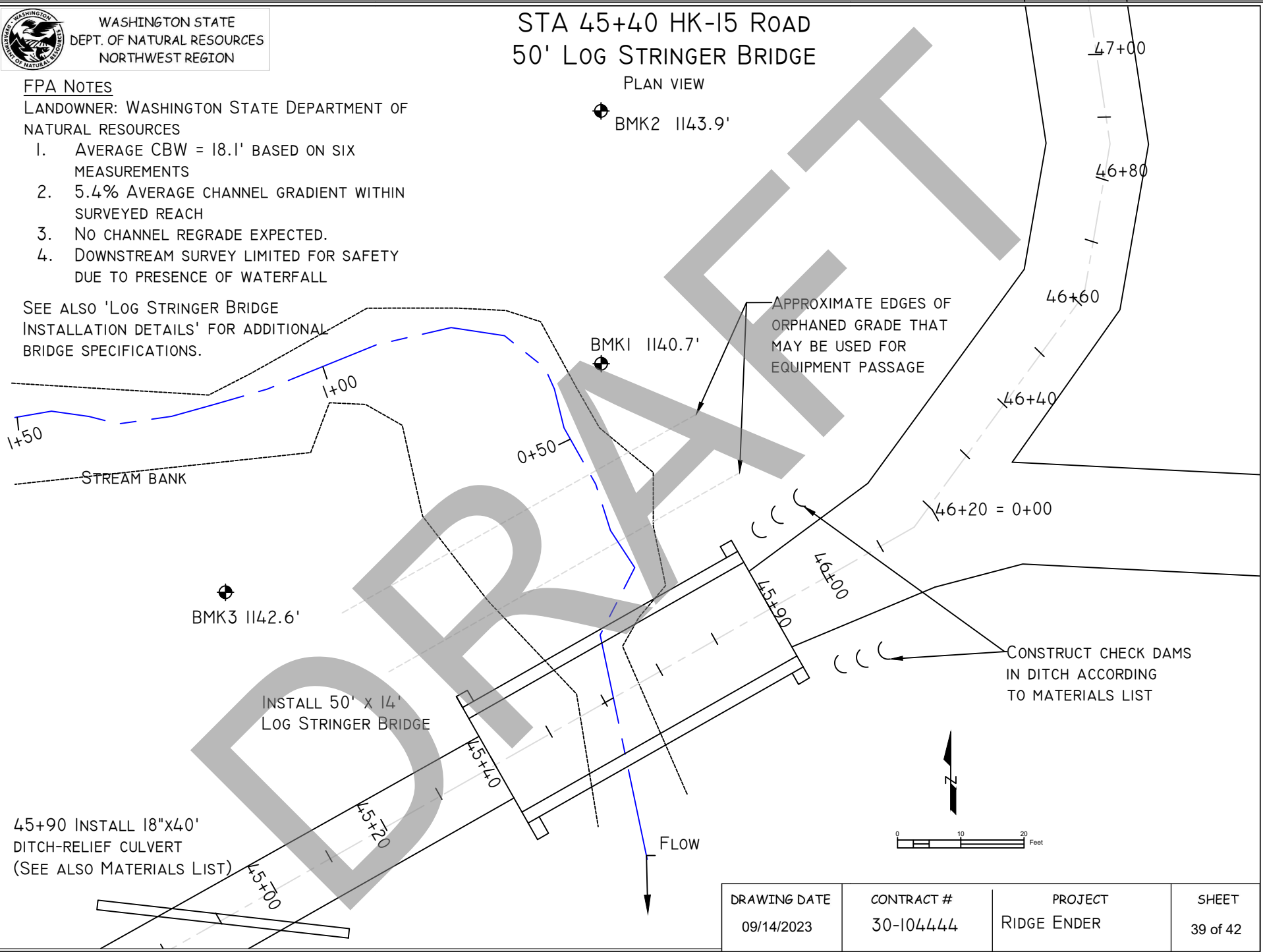

DRAWING DATE	CONTRACT #	PROJECT	SHEET
09/14/2023	30-104444	RIDGE ENDER	39 of 42



WASHINGTON STATE
DEPT. OF NATURAL RESOURCES
NORTHWEST REGION

STA 45+40 HK-15 ROAD 50' LOG STRINGER BRIDGE

PROFILE VIEW

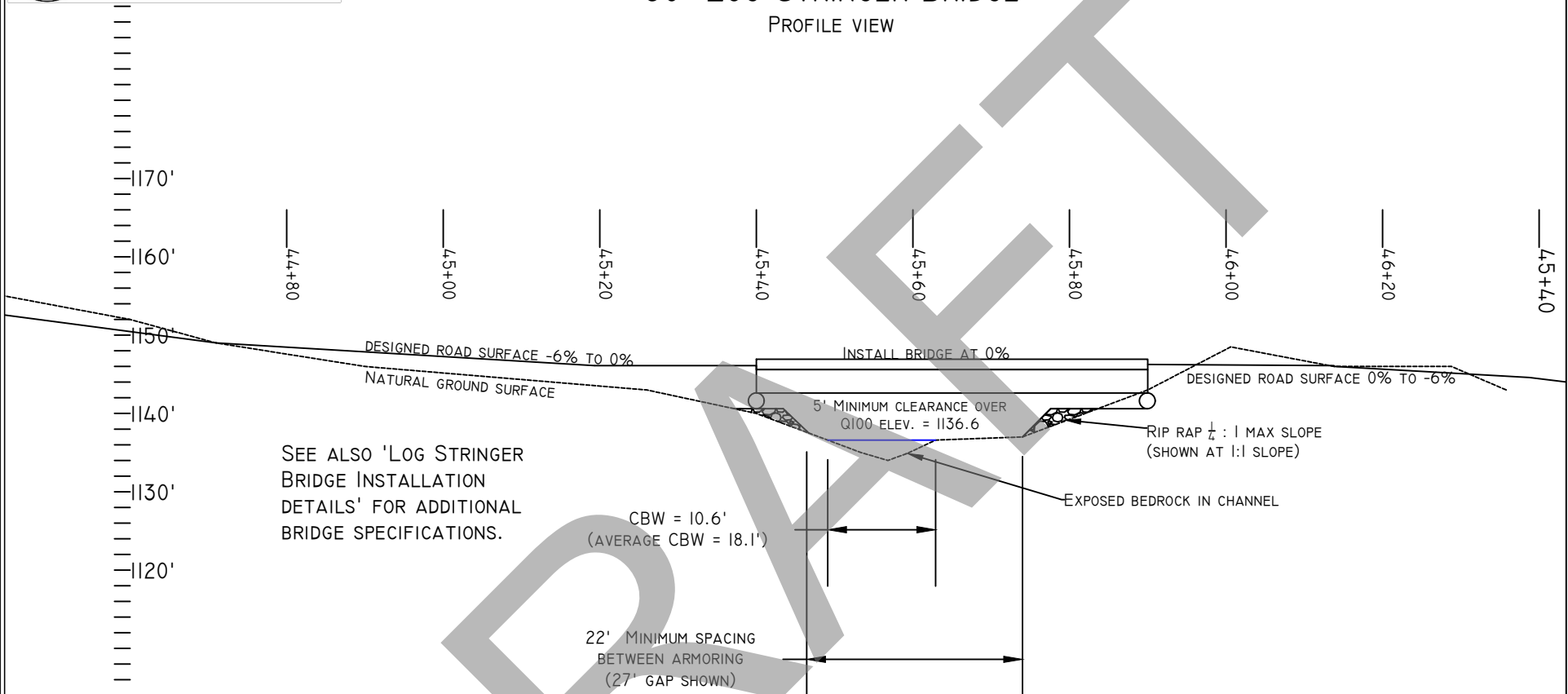

STREAM PROFILE AND BRIDGE CROSS SECTION (1:40)

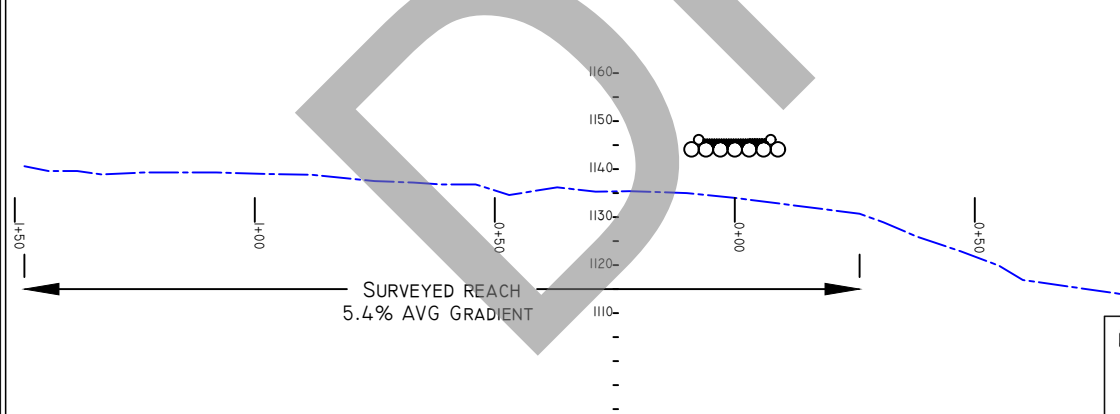



WASHINGTON STATE
DEPT. OF NATURAL RESOURCES
NORTHWEST REGION

STA 59+00 HK-15 ROAD
50' LOG STRINGER BRIDGE
PLAN VIEW

BMK2 1072.6'

BMK1 1060.0'

CONSTRUCT CHECK DAMS
IN DITCH ACCORDING
TO MATERIALS LIST

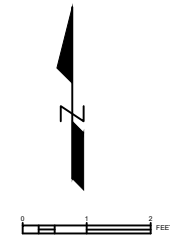

FPA NOTES

LANDOWNER: WASHINGTON STATE DEPARTMENT OF
NATURAL RESOURCES

1. CBW 8' BASED ON NINE MEASUREMENTS
2. 19% AVERAGE CHANNEL GRADIENT WITHIN
SURVEYED REACH
3. NO CHANNEL REGRADE EXPECTED.

SEE ALSO 'LOG STRINGER BRIDGE INSTALLATION
DETAILS' FOR ADDITIONAL BRIDGE SPECIFICATIONS.

CONSTRUCT CHECK DAMS
IN DITCH ACCORDING
TO MATERIALS LIST

INSTALL 50' x 14'
LOG STRINGER BRIDGE

BMK3 1044.8'

DRAWING DATE	CONTRACT #	PROJECT	SHEET
09/14/2023	30-104444	RIDGE ENDER	41 of 42



STA 59+00 HK-15 ROAD 50' LOG STRINGER BRIDGE

PROFILE VIEW

SEE ALSO 'LOG STRINGER
BRIDGE INSTALLATION
DETAILS' FOR ADDITIONAL
BRIDGE SPECIFICATIONS.

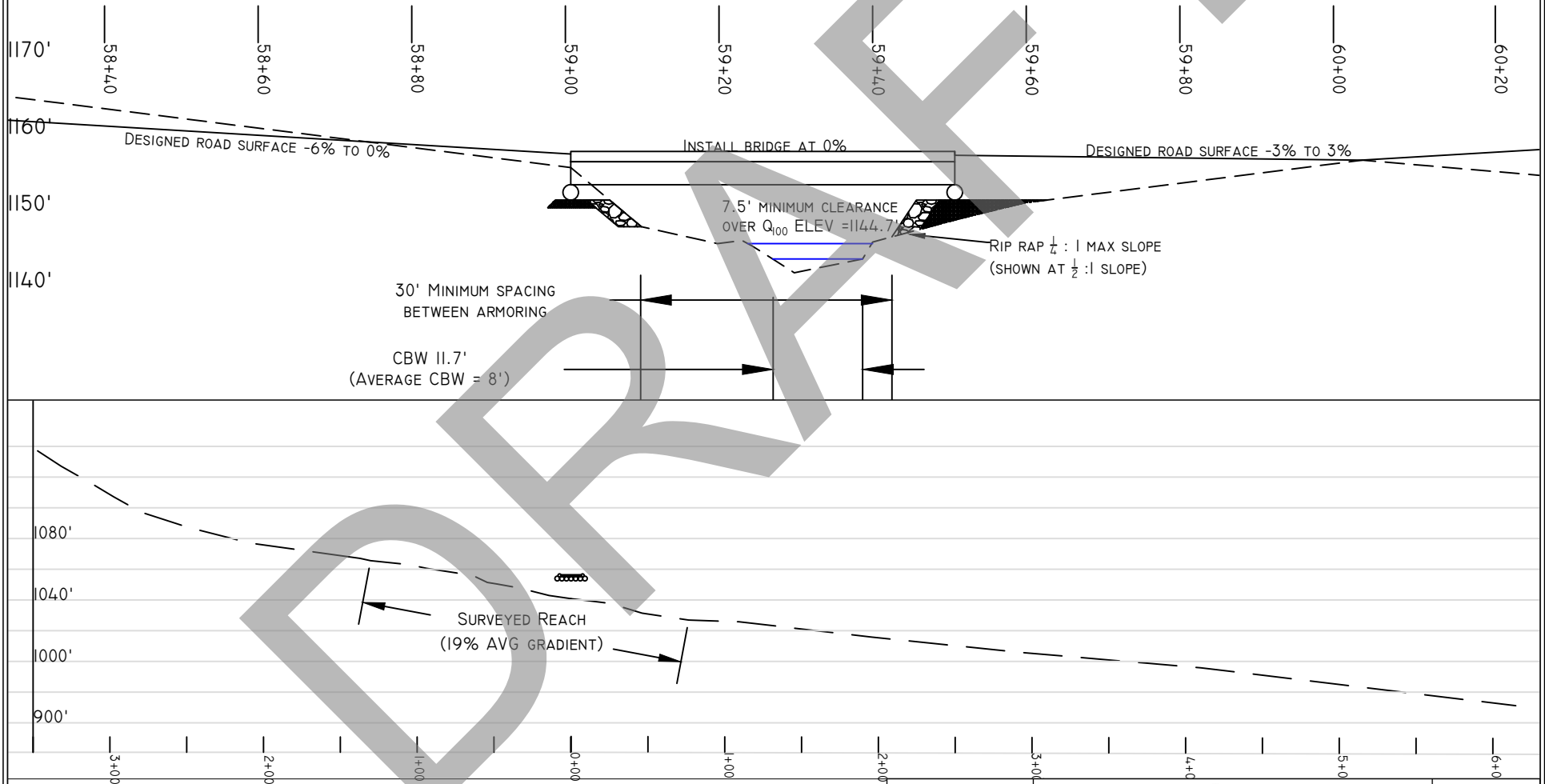

DRAWING DATE 09/14/2023	CONTRACT # 30-104444	PROJECT RIDGE ENDER	SHEET 42 of 42
----------------------------	-------------------------	------------------------	-------------------

SUMMARY - Road Development Costs

REGION: Northwest

DISTRICT: Cascade

SALE/PROJECT NAME:

RIDGE ENDER

CONTRACT #:

30-104444

ROAD NUMBERS:	HK-15, HK-1509, HK-18, HK-26, HK-2601, HK-27,	-	HK-ML, PT-14, HK-18,
ROAD STANDARD:	Construction	Reconstruction	Maintenance
NUMBER OF STATIONS:	121.80	0.00	185.50
CLEARING & GRUBBING:	\$16,884	\$0	\$0
EXCAVATION AND FILL:	\$29,034	\$0	\$0
MISC. MAINTENANCE:	\$240	-	\$7,115
ROAD ROCK:	\$114,903	\$0	\$0
ROCK STOCKPILE PROD:	-	-	-
CULVERTS AND FLUMES:	\$37,435	\$0	\$0
STRUCTURES:	\$43,248	\$0	\$0
MOBILIZATION:	\$8,100	\$0	\$275
TOTAL COSTS:	\$249,843	\$0	\$7,390
COST PER STATION:	\$2,051	N/A	\$40
ROAD DEACTIVATION & ABANDONMENT COSTS:		\$2,544	

TOTAL (All Roads) = \$259,778

ESTIMATED SALE VOLUME MBF = 4667

ESTIMATED TOTAL \$/MBF = \$56

Compiled by: A. HALGREN

Date: 9/25/2023